

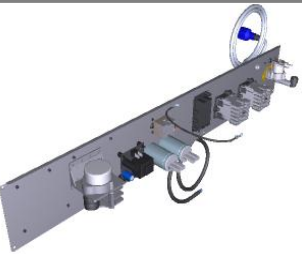

Codice assieme	Descrizione assieme	Immagine assieme
ASM0027B/0.D00	Porta	
ASM2012D/0.D00	Camera di cottura	
ASM2013D/0.D01	Copertura esterna	
ASM2014F/0.D00	Impianto elettrico	

ASM0027B/0.D00 - Porta

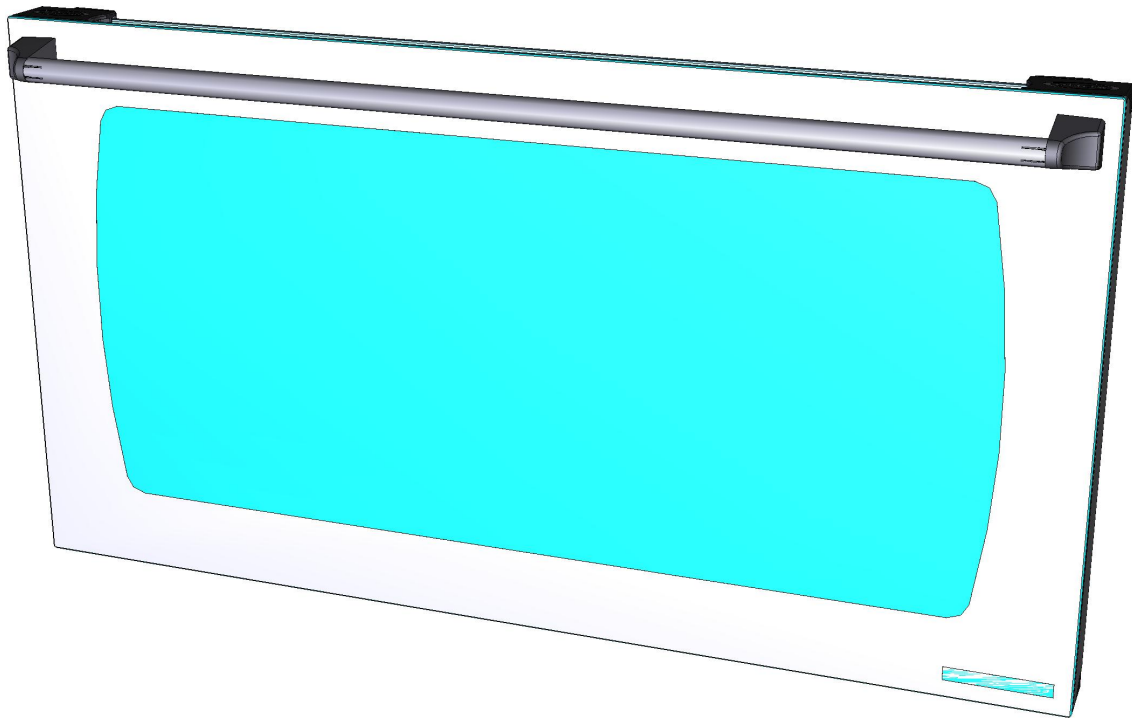

FRONTE





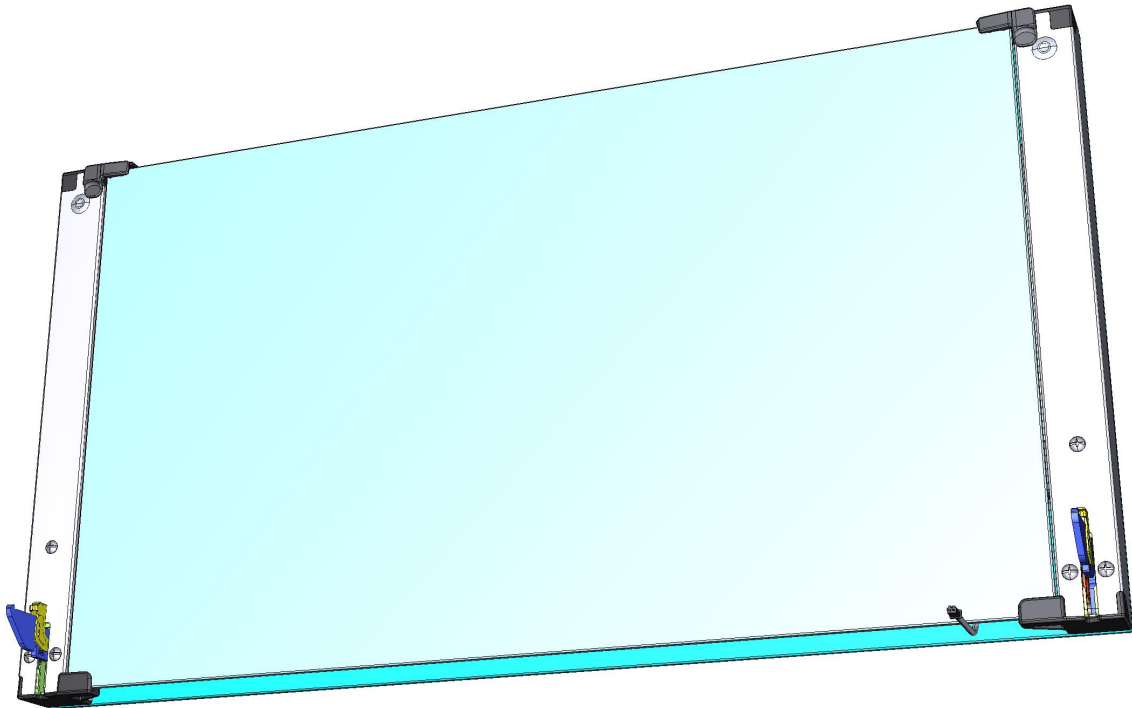

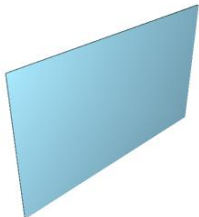
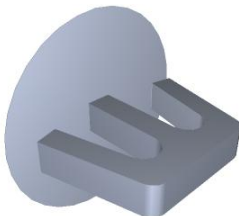
ASM0027B/0.D00 - Porta

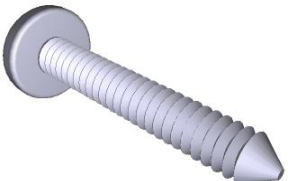
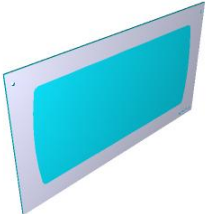

RETRO

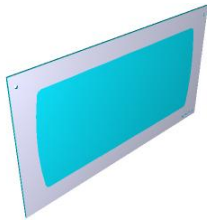



COMPONENTE			RICAMBIO																																		
Codice	Descrizione	Immagine	Codice	Descrizione	Lista componenti																																
VT1070B	VETRO INTERNO 715X415X6 LMISS ROSSELLA		KVT1070B	KIT VETRO INTERNO LM ROSSELLA	<table border="1"> <thead> <tr> <th>Codice</th> <th>Descrizione</th> <th>Qtà</th> <th>UM</th> </tr> </thead> <tbody> <tr> <td>ED1011A0</td> <td>ETICHETTA VETRO LATO BASSO EMISSIVO</td> <td>1</td> <td>PZ</td> </tr> <tr> <td>ED1235A0</td> <td>ETICHETTA VETRO INTERNO PER RICAMBI</td> <td>1</td> <td>PZ</td> </tr> <tr> <td>GN1265A0</td> <td>GUARNIZIONE VETRO INTERNO</td> <td>4</td> <td>PZ</td> </tr> <tr> <td>IP1508A1</td> <td>POLISTIROLO PROFILO AD U 2000X60X60</td> <td>1.130</td> <td>M</td> </tr> <tr> <td>VM1059A1</td> <td>FILM TERMORETRA IBILE H800</td> <td>1.700</td> <td>M</td> </tr> <tr> <td>VT1070B0</td> <td>VETRO INTERNO 715X415X6 LMISS ROSSELLA</td> <td>1</td> <td>PZ</td> </tr> <tr> <td>VT1070B0</td> <td>VETRO INTERNO 715X415X6 LMISS ROSSELLA</td> <td>1</td> <td>PZ</td> </tr> </tbody> </table>	Codice	Descrizione	Qtà	UM	ED1011A0	ETICHETTA VETRO LATO BASSO EMISSIVO	1	PZ	ED1235A0	ETICHETTA VETRO INTERNO PER RICAMBI	1	PZ	GN1265A0	GUARNIZIONE VETRO INTERNO	4	PZ	IP1508A1	POLISTIROLO PROFILO AD U 2000X60X60	1.130	M	VM1059A1	FILM TERMORETRA IBILE H800	1.700	M	VT1070B0	VETRO INTERNO 715X415X6 LMISS ROSSELLA	1	PZ	VT1070B0	VETRO INTERNO 715X415X6 LMISS ROSSELLA	1	PZ
Codice	Descrizione	Qtà	UM																																		
ED1011A0	ETICHETTA VETRO LATO BASSO EMISSIVO	1	PZ																																		
ED1235A0	ETICHETTA VETRO INTERNO PER RICAMBI	1	PZ																																		
GN1265A0	GUARNIZIONE VETRO INTERNO	4	PZ																																		
IP1508A1	POLISTIROLO PROFILO AD U 2000X60X60	1.130	M																																		
VM1059A1	FILM TERMORETRA IBILE H800	1.700	M																																		
VT1070B0	VETRO INTERNO 715X415X6 LMISS ROSSELLA	1	PZ																																		
VT1070B0	VETRO INTERNO 715X415X6 LMISS ROSSELLA	1	PZ																																		
VM1025A	TAPPO NYLON PA66 V2 GRIGIO Ø16		KVM1025A	KIT 20 TAPPI NYLON PA66 V2 GRIGIO D 6	<table border="1"> <thead> <tr> <th>Codice</th> <th>Descrizione</th> <th>Qtà</th> <th>UM</th> </tr> </thead> <tbody> <tr> <td>VM1025A0</td> <td>TAPPO NYLON PA66 V2 GRIGIO Ø16</td> <td>20</td> <td>PZ</td> </tr> </tbody> </table>	Codice	Descrizione	Qtà	UM	VM1025A0	TAPPO NYLON PA66 V2 GRIGIO Ø16	20	PZ																								
Codice	Descrizione	Qtà	UM																																		
VM1025A0	TAPPO NYLON PA66 V2 GRIGIO Ø16	20	PZ																																		
MG1015B	TERMINALE MANIGLIA LMISS/LMICRO/CHE FTOP		KMG1015B	KIT 2 PZ.TERMINALE MANIGLIA	<table border="1"> <thead> <tr> <th>Codice</th> <th>Descrizione</th> <th>Qtà</th> <th>UM</th> </tr> </thead> <tbody> <tr> <td>MG1015B0</td> <td>TERMINALE MANIGLIA LMISS/LMICR Q/CHEFTOP</td> <td>2</td> <td>PZ</td> </tr> <tr> <td>V11855A0</td> <td>VITE AUTOFIL. 5X25 TCB+</td> <td>2</td> <td>PZ</td> </tr> <tr> <td>V11870A0</td> <td>VITE AUTOFIL. X PLASTICA 5X50 TCB+</td> <td>2</td> <td>PZ</td> </tr> <tr> <td>VM1025A0</td> <td>TAPPO NYLON PA66 V2 GRIGIO Ø16</td> <td>2</td> <td>PZ</td> </tr> </tbody> </table>	Codice	Descrizione	Qtà	UM	MG1015B0	TERMINALE MANIGLIA LMISS/LMICR Q/CHEFTOP	2	PZ	V11855A0	VITE AUTOFIL. 5X25 TCB+	2	PZ	V11870A0	VITE AUTOFIL. X PLASTICA 5X50 TCB+	2	PZ	VM1025A0	TAPPO NYLON PA66 V2 GRIGIO Ø16	2	PZ												
Codice	Descrizione	Qtà	UM																																		
MG1015B0	TERMINALE MANIGLIA LMISS/LMICR Q/CHEFTOP	2	PZ																																		
V11855A0	VITE AUTOFIL. 5X25 TCB+	2	PZ																																		
V11870A0	VITE AUTOFIL. X PLASTICA 5X50 TCB+	2	PZ																																		
VM1025A0	TAPPO NYLON PA66 V2 GRIGIO Ø16	2	PZ																																		

COMPONENTE			RICAMBIO																																																														
Codice	Descrizione	Immagine	Codice	Descrizione	Lista componenti																																																												
VI1855A	VITE AUTOFIL. 5X25 TCB+		KVI1855A	KIT VITE 5X25 UTOFILETTANTE 20 PZ.	<table border="1"> <thead> <tr> <th>Codice</th> <th>Descrizione</th> <th>Qtà</th> <th>UM</th> </tr> </thead> <tbody> <tr> <td>VI1855A0</td> <td>VITE AUTOFIL. 5X25 TCB+</td> <td>20</td> <td>PZ</td> </tr> </tbody> </table>	Codice	Descrizione	Qtà	UM	VI1855A0	VITE AUTOFIL. 5X25 TCB+	20	PZ																																																				
Codice	Descrizione	Qtà	UM																																																														
VI1855A0	VITE AUTOFIL. 5X25 TCB+	20	PZ																																																														
VT1072A	VETRO EST. 798X424 NERO LMISS ROSSELLA		KVT1072A	KIT VETRO ESTERNO LM ROSSELLA BLACK	<table border="1"> <thead> <tr> <th>Codice</th> <th>Descrizione</th> <th>Qtà</th> <th>UM</th> </tr> </thead> <tbody> <tr> <td>IP1385A1</td> <td>IMB POL ANGOLARE 110X80X2000 D30</td> <td>0.960</td> <td>M</td> </tr> <tr> <td>IP1508A1</td> <td>POLISTIROLO PROFILO AD U 2000X60X60</td> <td>1.270</td> <td>M</td> </tr> <tr> <td>RC1200A0</td> <td>MOLLA A COMPRESSIO NE DE4 DF0.5 H24</td> <td>2</td> <td>PZ</td> </tr> <tr> <td>SL1050A1</td> <td>NASTRO BIADESIVO 3M TRANSFER VH</td> <td>0.820</td> <td>M</td> </tr> <tr> <td>TB2301A0</td> <td>COLONNINA DX XVC105E 40X40X1</td> <td>1</td> <td>PZ</td> </tr> <tr> <td>TB3081A0</td> <td>COLONNINA SX LM ARI-RO</td> <td>1</td> <td>PZ</td> </tr> <tr> <td>VM1025A0</td> <td>TAPPO NYLON PA66 V2 GRIGIO Ø16</td> <td>2</td> <td>PZ</td> </tr> <tr> <td>VM1059A1</td> <td>FILM TERMORETRA IBILE H800</td> <td>1.300</td> <td>M</td> </tr> <tr> <td>VM1695A0</td> <td>PERNO POSIZIONE MANIGLIA</td> <td>2</td> <td>PZ</td> </tr> <tr> <td>VM1916A0</td> <td>TAPPO COLONNINA SUP DX</td> <td>1</td> <td>PZ</td> </tr> <tr> <td>VM1917A0</td> <td>TAPPO COLONNINA SUP SX</td> <td>1</td> <td>PZ</td> </tr> <tr> <td>VM1918A0</td> <td>TAPPO COLONNINA INF DX</td> <td>1</td> <td>PZ</td> </tr> <tr> <td>VM1919A0</td> <td>TAPPO COLONNINA INF SX</td> <td>1</td> <td>PZ</td> </tr> <tr> <td>VM1920A0</td> <td>PIASTRINA DX CHIUSURA VETRO INT</td> <td>1</td> <td>PZ</td> </tr> </tbody> </table>	Codice	Descrizione	Qtà	UM	IP1385A1	IMB POL ANGOLARE 110X80X2000 D30	0.960	M	IP1508A1	POLISTIROLO PROFILO AD U 2000X60X60	1.270	M	RC1200A0	MOLLA A COMPRESSIO NE DE4 DF0.5 H24	2	PZ	SL1050A1	NASTRO BIADESIVO 3M TRANSFER VH	0.820	M	TB2301A0	COLONNINA DX XVC105E 40X40X1	1	PZ	TB3081A0	COLONNINA SX LM ARI-RO	1	PZ	VM1025A0	TAPPO NYLON PA66 V2 GRIGIO Ø16	2	PZ	VM1059A1	FILM TERMORETRA IBILE H800	1.300	M	VM1695A0	PERNO POSIZIONE MANIGLIA	2	PZ	VM1916A0	TAPPO COLONNINA SUP DX	1	PZ	VM1917A0	TAPPO COLONNINA SUP SX	1	PZ	VM1918A0	TAPPO COLONNINA INF DX	1	PZ	VM1919A0	TAPPO COLONNINA INF SX	1	PZ	VM1920A0	PIASTRINA DX CHIUSURA VETRO INT	1	PZ
Codice	Descrizione	Qtà	UM																																																														
IP1385A1	IMB POL ANGOLARE 110X80X2000 D30	0.960	M																																																														
IP1508A1	POLISTIROLO PROFILO AD U 2000X60X60	1.270	M																																																														
RC1200A0	MOLLA A COMPRESSIO NE DE4 DF0.5 H24	2	PZ																																																														
SL1050A1	NASTRO BIADESIVO 3M TRANSFER VH	0.820	M																																																														
TB2301A0	COLONNINA DX XVC105E 40X40X1	1	PZ																																																														
TB3081A0	COLONNINA SX LM ARI-RO	1	PZ																																																														
VM1025A0	TAPPO NYLON PA66 V2 GRIGIO Ø16	2	PZ																																																														
VM1059A1	FILM TERMORETRA IBILE H800	1.300	M																																																														
VM1695A0	PERNO POSIZIONE MANIGLIA	2	PZ																																																														
VM1916A0	TAPPO COLONNINA SUP DX	1	PZ																																																														
VM1917A0	TAPPO COLONNINA SUP SX	1	PZ																																																														
VM1918A0	TAPPO COLONNINA INF DX	1	PZ																																																														
VM1919A0	TAPPO COLONNINA INF SX	1	PZ																																																														
VM1920A0	PIASTRINA DX CHIUSURA VETRO INT	1	PZ																																																														

COMPONENTE			RICAMBIO																														
Codice	Descrizione	Immagine	Codice	Descrizione	Lista componenti																												
VT1072A	VETRO EST. 798X424 NERO LMISS ROSSELLA		KVT1072A	KIT VETRO ESTERNO LM ROSSELLA BLACK	<table border="1"> <thead> <tr> <th>Codice</th> <th>Descrizione</th> <th>Qtà</th> <th>UM</th> </tr> </thead> <tbody> <tr> <td>VM1921A0</td> <td>PIASTRINA SX CHIUSURA VETRO INT</td> <td>1</td> <td>PZ</td> </tr> <tr> <td>VT1072A0</td> <td>VETRO EST. 798X424 NERO LMISS ROSSELLA</td> <td>1</td> <td>PZ</td> </tr> <tr> <td>VT1072A0</td> <td>VETRO EST. 798X424 NERO LMISS ROSSELLA</td> <td>1</td> <td>PZ</td> </tr> </tbody> </table>	Codice	Descrizione	Qtà	UM	VM1921A0	PIASTRINA SX CHIUSURA VETRO INT	1	PZ	VT1072A0	VETRO EST. 798X424 NERO LMISS ROSSELLA	1	PZ	VT1072A0	VETRO EST. 798X424 NERO LMISS ROSSELLA	1	PZ												
Codice	Descrizione	Qtà	UM																														
VM1921A0	PIASTRINA SX CHIUSURA VETRO INT	1	PZ																														
VT1072A0	VETRO EST. 798X424 NERO LMISS ROSSELLA	1	PZ																														
VT1072A0	VETRO EST. 798X424 NERO LMISS ROSSELLA	1	PZ																														
CR1050A	CERNIERA PORTA XVC105/DECK/ROSS ELLA		KCR1050A	KIT CERNIERE XVC105/DECK/ROSS ELLA	<table border="1"> <thead> <tr> <th>Codice</th> <th>Descrizione</th> <th>Qtà</th> <th>UM</th> </tr> </thead> <tbody> <tr> <td>CR1050A1</td> <td>CERNIERA PORTA XVC105/DECK/ ROSSELLA</td> <td>2</td> <td>PZ</td> </tr> <tr> <td>VI1875A0</td> <td>VITE M5X10 TC1/2T INOX</td> <td>6</td> <td>PZ</td> </tr> </tbody> </table>	Codice	Descrizione	Qtà	UM	CR1050A1	CERNIERA PORTA XVC105/DECK/ ROSSELLA	2	PZ	VI1875A0	VITE M5X10 TC1/2T INOX	6	PZ																
Codice	Descrizione	Qtà	UM																														
CR1050A1	CERNIERA PORTA XVC105/DECK/ ROSSELLA	2	PZ																														
VI1875A0	VITE M5X10 TC1/2T INOX	6	PZ																														
0H1930B	TUBO MANIGLIA L= 718 Ø18X1		K0H1930B	KIT MANIGLIA LMISS 800	<table border="1"> <thead> <tr> <th>Codice</th> <th>Descrizione</th> <th>Qtà</th> <th>UM</th> </tr> </thead> <tbody> <tr> <td>0H1930B0</td> <td>TUBO MANIGLIA L= 718 Ø18X1</td> <td>1</td> <td>PZ</td> </tr> <tr> <td>MG1015B0</td> <td>TERMINALE MANIGLIA LMISS/LMICR O/CHEFTOP</td> <td>2</td> <td>PZ</td> </tr> <tr> <td>VI1855A0</td> <td>VITE AUTOFIL. 5X25 TCB+</td> <td>2</td> <td>PZ</td> </tr> <tr> <td>VM1025A0</td> <td>TAPPO NYLON PA66 V2 GRIGIO Ø16</td> <td>2</td> <td>PZ</td> </tr> <tr> <td>VM1794A0</td> <td>FASCETTA 250X4.8 PA66 NERA</td> <td>2</td> <td>PZ</td> </tr> <tr> <td>VM2103A0</td> <td>PIASTRINA FERMAFASCE TTA</td> <td>2</td> <td>PZ</td> </tr> </tbody> </table>	Codice	Descrizione	Qtà	UM	0H1930B0	TUBO MANIGLIA L= 718 Ø18X1	1	PZ	MG1015B0	TERMINALE MANIGLIA LMISS/LMICR O/CHEFTOP	2	PZ	VI1855A0	VITE AUTOFIL. 5X25 TCB+	2	PZ	VM1025A0	TAPPO NYLON PA66 V2 GRIGIO Ø16	2	PZ	VM1794A0	FASCETTA 250X4.8 PA66 NERA	2	PZ	VM2103A0	PIASTRINA FERMAFASCE TTA	2	PZ
Codice	Descrizione	Qtà	UM																														
0H1930B0	TUBO MANIGLIA L= 718 Ø18X1	1	PZ																														
MG1015B0	TERMINALE MANIGLIA LMISS/LMICR O/CHEFTOP	2	PZ																														
VI1855A0	VITE AUTOFIL. 5X25 TCB+	2	PZ																														
VM1025A0	TAPPO NYLON PA66 V2 GRIGIO Ø16	2	PZ																														
VM1794A0	FASCETTA 250X4.8 PA66 NERA	2	PZ																														
VM2103A0	PIASTRINA FERMAFASCE TTA	2	PZ																														
VM1918A	TAPPO COLONNINA INF DX		KVM1918A	KIT TAPPO COLONNINA INFERIORE DX LM80	<table border="1"> <thead> <tr> <th>Codice</th> <th>Descrizione</th> <th>Qtà</th> <th>UM</th> </tr> </thead> <tbody> <tr> <td>VM1918A0</td> <td>TAPPO COLONNINA INF DX</td> <td>1</td> <td>PZ</td> </tr> </tbody> </table>	Codice	Descrizione	Qtà	UM	VM1918A0	TAPPO COLONNINA INF DX	1	PZ																				
Codice	Descrizione	Qtà	UM																														
VM1918A0	TAPPO COLONNINA INF DX	1	PZ																														

COMPONENTE			RICAMBIO																																																																		
Codice	Descrizione	Immagine	Codice	Descrizione	Lista componenti																																																																
VM1919A	TAPPO COLONNINA INF SX		KVM1919A	KIT TAPPO COLONNINA INFERIORE SX LM80	<table border="1"> <thead> <tr> <th>Codice</th> <th>Descrizione</th> <th>Qtà</th> <th>UM</th> </tr> </thead> <tbody> <tr> <td>VM1919A0</td> <td>TAPPO COLONNINA INF SX</td> <td>1</td> <td>PZ</td> </tr> </tbody> </table>	Codice	Descrizione	Qtà	UM	VM1919A0	TAPPO COLONNINA INF SX	1	PZ																																																								
Codice	Descrizione	Qtà	UM																																																																		
VM1919A0	TAPPO COLONNINA INF SX	1	PZ																																																																		
VM1916A	TAPPO COLONNINA SUP DX		KVT1253A	KIT VETRO ESTERNO XF-XFT195-EG VT1253A	<table border="1"> <thead> <tr> <th>Codice</th> <th>Descrizione</th> <th>Qtà</th> <th>UM</th> </tr> </thead> <tbody> <tr> <td>IP1235B0</td> <td>IMBALLO POLISTIROLO PIANO</td> <td>1</td> <td>PZ</td> </tr> <tr> <td>RC1200A0</td> <td>MOLLA A COMPRESSIO NE DE4 DF0.5 H24</td> <td>2</td> <td>PZ</td> </tr> <tr> <td>SL1050A1</td> <td>NASTRO BIADESIVO 3M TRANSFER VH</td> <td>0.820</td> <td>M</td> </tr> <tr> <td>TB2301A0</td> <td>COLONNINA DX XVC105E 40X40X1</td> <td>1</td> <td>PZ</td> </tr> <tr> <td>TB3081A0</td> <td>COLONNINA SX LM ARI-RO</td> <td>1</td> <td>PZ</td> </tr> <tr> <td>VM1025A0</td> <td>TAPPO NYLON PA66 V2 GRIGIO Ø16</td> <td>2</td> <td>PZ</td> </tr> <tr> <td>VM1695A0</td> <td>PERNO POSIZIONE MANIGLIA</td> <td>2</td> <td>PZ</td> </tr> <tr> <td>VM1916A0</td> <td>TAPPO COLONNINA SUP DX</td> <td>1</td> <td>PZ</td> </tr> <tr> <td>VM1917A0</td> <td>TAPPO COLONNINA SUP SX</td> <td>1</td> <td>PZ</td> </tr> <tr> <td>VM1918A0</td> <td>TAPPO COLONNINA INF DX</td> <td>1</td> <td>PZ</td> </tr> <tr> <td>VM1919A0</td> <td>TAPPO COLONNINA INF SX</td> <td>1</td> <td>PZ</td> </tr> <tr> <td>VM1920A0</td> <td>PIASTRINA DX CHIUSURA VETRO INT</td> <td>1</td> <td>PZ</td> </tr> <tr> <td>VM1921A0</td> <td>PIASTRINA SX CHIUSURA VETRO INT</td> <td>1</td> <td>PZ</td> </tr> <tr> <td>VT1253A0</td> <td>VETRO EST.XF-XFT 195 NERO ENGEFOOD</td> <td>1</td> <td>PZ</td> </tr> <tr> <td>VT1253A0</td> <td>VETRO EST.XF-XFT 195 NERO ENGEFOOD</td> <td>1</td> <td>PZ</td> </tr> </tbody> </table>	Codice	Descrizione	Qtà	UM	IP1235B0	IMBALLO POLISTIROLO PIANO	1	PZ	RC1200A0	MOLLA A COMPRESSIO NE DE4 DF0.5 H24	2	PZ	SL1050A1	NASTRO BIADESIVO 3M TRANSFER VH	0.820	M	TB2301A0	COLONNINA DX XVC105E 40X40X1	1	PZ	TB3081A0	COLONNINA SX LM ARI-RO	1	PZ	VM1025A0	TAPPO NYLON PA66 V2 GRIGIO Ø16	2	PZ	VM1695A0	PERNO POSIZIONE MANIGLIA	2	PZ	VM1916A0	TAPPO COLONNINA SUP DX	1	PZ	VM1917A0	TAPPO COLONNINA SUP SX	1	PZ	VM1918A0	TAPPO COLONNINA INF DX	1	PZ	VM1919A0	TAPPO COLONNINA INF SX	1	PZ	VM1920A0	PIASTRINA DX CHIUSURA VETRO INT	1	PZ	VM1921A0	PIASTRINA SX CHIUSURA VETRO INT	1	PZ	VT1253A0	VETRO EST.XF-XFT 195 NERO ENGEFOOD	1	PZ	VT1253A0	VETRO EST.XF-XFT 195 NERO ENGEFOOD	1	PZ
Codice	Descrizione	Qtà	UM																																																																		
IP1235B0	IMBALLO POLISTIROLO PIANO	1	PZ																																																																		
RC1200A0	MOLLA A COMPRESSIO NE DE4 DF0.5 H24	2	PZ																																																																		
SL1050A1	NASTRO BIADESIVO 3M TRANSFER VH	0.820	M																																																																		
TB2301A0	COLONNINA DX XVC105E 40X40X1	1	PZ																																																																		
TB3081A0	COLONNINA SX LM ARI-RO	1	PZ																																																																		
VM1025A0	TAPPO NYLON PA66 V2 GRIGIO Ø16	2	PZ																																																																		
VM1695A0	PERNO POSIZIONE MANIGLIA	2	PZ																																																																		
VM1916A0	TAPPO COLONNINA SUP DX	1	PZ																																																																		
VM1917A0	TAPPO COLONNINA SUP SX	1	PZ																																																																		
VM1918A0	TAPPO COLONNINA INF DX	1	PZ																																																																		
VM1919A0	TAPPO COLONNINA INF SX	1	PZ																																																																		
VM1920A0	PIASTRINA DX CHIUSURA VETRO INT	1	PZ																																																																		
VM1921A0	PIASTRINA SX CHIUSURA VETRO INT	1	PZ																																																																		
VT1253A0	VETRO EST.XF-XFT 195 NERO ENGEFOOD	1	PZ																																																																		
VT1253A0	VETRO EST.XF-XFT 195 NERO ENGEFOOD	1	PZ																																																																		

COMPONENTE			RICAMBIO																																																																										
Codice	Descrizione	Immagine	Codice	Descrizione	Lista componenti																																																																								
VM1916A	TAPPO COLONNINA SUP DX		KVT1072A	KIT VETRO ESTERNO LM ROSSELLA BLACK	<table border="1"> <thead> <tr> <th>Codice</th> <th>Descrizione</th> <th>Qtà</th> <th>UM</th> </tr> </thead> <tbody> <tr> <td>IP1385A1</td> <td>IMB POL ANGOLARE 110X80X2000 D30</td> <td>0.960</td> <td>M</td> </tr> <tr> <td>IP1508A1</td> <td>POLISTIROLO PROFILO AD U 2000X60X60</td> <td>1.270</td> <td>M</td> </tr> <tr> <td>RC1200A0</td> <td>MOLLA A COMPRESSIO NE DE4 DF0.5 H24</td> <td>2</td> <td>PZ</td> </tr> <tr> <td>SL1050A1</td> <td>NASTRO BIADESIVO 3M TRANSFER VH</td> <td>0.820</td> <td>M</td> </tr> <tr> <td>TB2301A0</td> <td>COLONNINA DX XVC105E 40X40X1</td> <td>1</td> <td>PZ</td> </tr> <tr> <td>TB3081A0</td> <td>COLONNINA SX LM ARI-RO</td> <td>1</td> <td>PZ</td> </tr> <tr> <td>VM1025A0</td> <td>TAPPO NYLON PA66 V2 GRIGIO Ø16</td> <td>2</td> <td>PZ</td> </tr> <tr> <td>VM1059A1</td> <td>FILM TERMORETRA IBILE H800</td> <td>1.300</td> <td>M</td> </tr> <tr> <td>VM1695A0</td> <td>PERNO POSIZIONE MANIGLIA</td> <td>2</td> <td>PZ</td> </tr> <tr> <td>VM1916A0</td> <td>TAPPO COLONNINA SUP DX</td> <td>1</td> <td>PZ</td> </tr> <tr> <td>VM1917A0</td> <td>TAPPO COLONNINA SUP SX</td> <td>1</td> <td>PZ</td> </tr> <tr> <td>VM1918A0</td> <td>TAPPO COLONNINA INF DX</td> <td>1</td> <td>PZ</td> </tr> <tr> <td>VM1919A0</td> <td>TAPPO COLONNINA INF SX</td> <td>1</td> <td>PZ</td> </tr> <tr> <td>VM1920A0</td> <td>PIASTRINA DX CHIUSURA VETRO INT</td> <td>1</td> <td>PZ</td> </tr> <tr> <td>VM1921A0</td> <td>PIASTRINA SX CHIUSURA VETRO INT</td> <td>1</td> <td>PZ</td> </tr> <tr> <td>VT1072A0</td> <td>VETRO EST. 798X424 NERO LMISS ROSSELLA</td> <td>1</td> <td>PZ</td> </tr> <tr> <td>VT1072A0</td> <td>VETRO EST. 798X424 NERO LMISS ROSSELLA</td> <td>1</td> <td>PZ</td> </tr> </tbody> </table>	Codice	Descrizione	Qtà	UM	IP1385A1	IMB POL ANGOLARE 110X80X2000 D30	0.960	M	IP1508A1	POLISTIROLO PROFILO AD U 2000X60X60	1.270	M	RC1200A0	MOLLA A COMPRESSIO NE DE4 DF0.5 H24	2	PZ	SL1050A1	NASTRO BIADESIVO 3M TRANSFER VH	0.820	M	TB2301A0	COLONNINA DX XVC105E 40X40X1	1	PZ	TB3081A0	COLONNINA SX LM ARI-RO	1	PZ	VM1025A0	TAPPO NYLON PA66 V2 GRIGIO Ø16	2	PZ	VM1059A1	FILM TERMORETRA IBILE H800	1.300	M	VM1695A0	PERNO POSIZIONE MANIGLIA	2	PZ	VM1916A0	TAPPO COLONNINA SUP DX	1	PZ	VM1917A0	TAPPO COLONNINA SUP SX	1	PZ	VM1918A0	TAPPO COLONNINA INF DX	1	PZ	VM1919A0	TAPPO COLONNINA INF SX	1	PZ	VM1920A0	PIASTRINA DX CHIUSURA VETRO INT	1	PZ	VM1921A0	PIASTRINA SX CHIUSURA VETRO INT	1	PZ	VT1072A0	VETRO EST. 798X424 NERO LMISS ROSSELLA	1	PZ	VT1072A0	VETRO EST. 798X424 NERO LMISS ROSSELLA	1	PZ
Codice	Descrizione	Qtà	UM																																																																										
IP1385A1	IMB POL ANGOLARE 110X80X2000 D30	0.960	M																																																																										
IP1508A1	POLISTIROLO PROFILO AD U 2000X60X60	1.270	M																																																																										
RC1200A0	MOLLA A COMPRESSIO NE DE4 DF0.5 H24	2	PZ																																																																										
SL1050A1	NASTRO BIADESIVO 3M TRANSFER VH	0.820	M																																																																										
TB2301A0	COLONNINA DX XVC105E 40X40X1	1	PZ																																																																										
TB3081A0	COLONNINA SX LM ARI-RO	1	PZ																																																																										
VM1025A0	TAPPO NYLON PA66 V2 GRIGIO Ø16	2	PZ																																																																										
VM1059A1	FILM TERMORETRA IBILE H800	1.300	M																																																																										
VM1695A0	PERNO POSIZIONE MANIGLIA	2	PZ																																																																										
VM1916A0	TAPPO COLONNINA SUP DX	1	PZ																																																																										
VM1917A0	TAPPO COLONNINA SUP SX	1	PZ																																																																										
VM1918A0	TAPPO COLONNINA INF DX	1	PZ																																																																										
VM1919A0	TAPPO COLONNINA INF SX	1	PZ																																																																										
VM1920A0	PIASTRINA DX CHIUSURA VETRO INT	1	PZ																																																																										
VM1921A0	PIASTRINA SX CHIUSURA VETRO INT	1	PZ																																																																										
VT1072A0	VETRO EST. 798X424 NERO LMISS ROSSELLA	1	PZ																																																																										
VT1072A0	VETRO EST. 798X424 NERO LMISS ROSSELLA	1	PZ																																																																										

COMPONENTE			RICAMBIO																																																																						
Codice	Descrizione	Immagine	Codice	Descrizione	Lista componenti																																																																				
VM1916A	TAPPO COLONNINA SUP DX		KVT1071A	KIT VETRO ESTERNO LM ROSSELLA	<table border="1"> <thead> <tr> <th>Codice</th> <th>Descrizione</th> <th>Qtà</th> <th>UM</th> </tr> </thead> <tbody> <tr> <td>IP1385A1</td> <td>IMB POL ANGOLARE 110X80X2000 D30</td> <td>0.960</td> <td>M</td> </tr> <tr> <td>IP1508A1</td> <td>POLISTIROLO PROFILO AD U 2000X60X60</td> <td>1.300</td> <td>M</td> </tr> <tr> <td>RC1200A0</td> <td>MOLLA A COMPRESSIO NE DE4 DF0.5 H24</td> <td>2</td> <td>PZ</td> </tr> <tr> <td>SL1050A1</td> <td>NASTRO BIADESIVO 3M TRANSFER VH</td> <td>0.820</td> <td>M</td> </tr> <tr> <td>TB2301A0</td> <td>COLONNINA DX XVC105E 40X40X1</td> <td>2</td> <td>PZ</td> </tr> <tr> <td>VM1025A0</td> <td>TAPPO NYLON PA66 V2 GRIGIO Ø16</td> <td>2</td> <td>PZ</td> </tr> <tr> <td>VM1059A1</td> <td>FILM TERMORETRA IBILE H800</td> <td>1.350</td> <td>M</td> </tr> <tr> <td>VM1695A0</td> <td>PERNO POSIZIONE MANIGLIA</td> <td>2</td> <td>PZ</td> </tr> <tr> <td>VM1916A0</td> <td>TAPPO COLONNINA SUP DX</td> <td>1</td> <td>PZ</td> </tr> <tr> <td>VM1917A0</td> <td>TAPPO COLONNINA SUP SX</td> <td>1</td> <td>PZ</td> </tr> <tr> <td>VM1918A0</td> <td>TAPPO COLONNINA INF DX</td> <td>1</td> <td>PZ</td> </tr> <tr> <td>VM1919A0</td> <td>TAPPO COLONNINA INF SX</td> <td>1</td> <td>PZ</td> </tr> <tr> <td>VM1920A0</td> <td>PIASTRINA DX CHIUSURA VETRO INT</td> <td>1</td> <td>PZ</td> </tr> <tr> <td>VM1921A0</td> <td>PIASTRINA SX CHIUSURA VETRO INT</td> <td>1</td> <td>PZ</td> </tr> <tr> <td>VT1071A2</td> <td>VETRO ESTERNO SER. GIALLO 798X424X5</td> <td>1</td> <td>PZ</td> </tr> <tr> <td>VT1071A2</td> <td>VETRO ESTERNO SER. GIALLO 798X424X5</td> <td>1</td> <td>PZ</td> </tr> </tbody> </table>	Codice	Descrizione	Qtà	UM	IP1385A1	IMB POL ANGOLARE 110X80X2000 D30	0.960	M	IP1508A1	POLISTIROLO PROFILO AD U 2000X60X60	1.300	M	RC1200A0	MOLLA A COMPRESSIO NE DE4 DF0.5 H24	2	PZ	SL1050A1	NASTRO BIADESIVO 3M TRANSFER VH	0.820	M	TB2301A0	COLONNINA DX XVC105E 40X40X1	2	PZ	VM1025A0	TAPPO NYLON PA66 V2 GRIGIO Ø16	2	PZ	VM1059A1	FILM TERMORETRA IBILE H800	1.350	M	VM1695A0	PERNO POSIZIONE MANIGLIA	2	PZ	VM1916A0	TAPPO COLONNINA SUP DX	1	PZ	VM1917A0	TAPPO COLONNINA SUP SX	1	PZ	VM1918A0	TAPPO COLONNINA INF DX	1	PZ	VM1919A0	TAPPO COLONNINA INF SX	1	PZ	VM1920A0	PIASTRINA DX CHIUSURA VETRO INT	1	PZ	VM1921A0	PIASTRINA SX CHIUSURA VETRO INT	1	PZ	VT1071A2	VETRO ESTERNO SER. GIALLO 798X424X5	1	PZ	VT1071A2	VETRO ESTERNO SER. GIALLO 798X424X5	1	PZ
Codice	Descrizione	Qtà	UM																																																																						
IP1385A1	IMB POL ANGOLARE 110X80X2000 D30	0.960	M																																																																						
IP1508A1	POLISTIROLO PROFILO AD U 2000X60X60	1.300	M																																																																						
RC1200A0	MOLLA A COMPRESSIO NE DE4 DF0.5 H24	2	PZ																																																																						
SL1050A1	NASTRO BIADESIVO 3M TRANSFER VH	0.820	M																																																																						
TB2301A0	COLONNINA DX XVC105E 40X40X1	2	PZ																																																																						
VM1025A0	TAPPO NYLON PA66 V2 GRIGIO Ø16	2	PZ																																																																						
VM1059A1	FILM TERMORETRA IBILE H800	1.350	M																																																																						
VM1695A0	PERNO POSIZIONE MANIGLIA	2	PZ																																																																						
VM1916A0	TAPPO COLONNINA SUP DX	1	PZ																																																																						
VM1917A0	TAPPO COLONNINA SUP SX	1	PZ																																																																						
VM1918A0	TAPPO COLONNINA INF DX	1	PZ																																																																						
VM1919A0	TAPPO COLONNINA INF SX	1	PZ																																																																						
VM1920A0	PIASTRINA DX CHIUSURA VETRO INT	1	PZ																																																																						
VM1921A0	PIASTRINA SX CHIUSURA VETRO INT	1	PZ																																																																						
VT1071A2	VETRO ESTERNO SER. GIALLO 798X424X5	1	PZ																																																																						
VT1071A2	VETRO ESTERNO SER. GIALLO 798X424X5	1	PZ																																																																						

COMPONENTE			RICAMBIO																																																																										
Codice	Descrizione	Immagine	Codice	Descrizione	Lista componenti																																																																								
VM1916A	TAPPO COLONNINA SUP DX		KVT1067A	KIT VETRO ESTERNO LM ELENA BLACK	<table border="1"> <thead> <tr> <th>Codice</th> <th>Descrizione</th> <th>Qtà</th> <th>UM</th> </tr> </thead> <tbody> <tr> <td>IP1385A1</td> <td>IMB POL ANGOLARE 110X80X2000 D30</td> <td>0.800</td> <td>M</td> </tr> <tr> <td>IP1508A1</td> <td>POLISTIROLO PROFILO AD U 2000X60X60</td> <td>1.710</td> <td>M</td> </tr> <tr> <td>RC1200A0</td> <td>MOLLA A COMPRESSIO NE DE4 DF0.5 H24</td> <td>2</td> <td>PZ</td> </tr> <tr> <td>SL1050A1</td> <td>NASTRO BIADESIVO 3M TRANSFER VH</td> <td>0.660</td> <td>M</td> </tr> <tr> <td>TB2306A0</td> <td>COLONNINA DX LM STE-ELE 40X40X1</td> <td>1</td> <td>PZ</td> </tr> <tr> <td>TB3080A0</td> <td>COLONNINA SX LM STE-EL</td> <td>1</td> <td>PZ</td> </tr> <tr> <td>VM1025A0</td> <td>TAPPO NYLON PA66 V2 GRIGIO Ø16</td> <td>2</td> <td>PZ</td> </tr> <tr> <td>VM1059A1</td> <td>FILM TERMORETRA IBILE H800</td> <td>1.350</td> <td>M</td> </tr> <tr> <td>VM1695A0</td> <td>PERNO POSIZIONE MANIGLIA</td> <td>2</td> <td>PZ</td> </tr> <tr> <td>VM1916A0</td> <td>TAPPO COLONNINA SUP DX</td> <td>1</td> <td>PZ</td> </tr> <tr> <td>VM1917A0</td> <td>TAPPO COLONNINA SUP SX</td> <td>1</td> <td>PZ</td> </tr> <tr> <td>VM1918A0</td> <td>TAPPO COLONNINA INF DX</td> <td>1</td> <td>PZ</td> </tr> <tr> <td>VM1919A0</td> <td>TAPPO COLONNINA INF SX</td> <td>1</td> <td>PZ</td> </tr> <tr> <td>VM1920A0</td> <td>PIASTRINA DX CHIUSURA VETRO INT</td> <td>1</td> <td>PZ</td> </tr> <tr> <td>VM1921A0</td> <td>PIASTRINA SX CHIUSURA VETRO INT</td> <td>1</td> <td>PZ</td> </tr> <tr> <td>VT1067A0</td> <td>VETRO ESTERNO GRIGIO 798X344X5 LM ELENA</td> <td>1</td> <td>PZ</td> </tr> <tr> <td>VT1067A0</td> <td>VETRO ESTERNO GRIGIO 798X344X5 LM ELENA</td> <td>1</td> <td>PZ</td> </tr> </tbody> </table>	Codice	Descrizione	Qtà	UM	IP1385A1	IMB POL ANGOLARE 110X80X2000 D30	0.800	M	IP1508A1	POLISTIROLO PROFILO AD U 2000X60X60	1.710	M	RC1200A0	MOLLA A COMPRESSIO NE DE4 DF0.5 H24	2	PZ	SL1050A1	NASTRO BIADESIVO 3M TRANSFER VH	0.660	M	TB2306A0	COLONNINA DX LM STE-ELE 40X40X1	1	PZ	TB3080A0	COLONNINA SX LM STE-EL	1	PZ	VM1025A0	TAPPO NYLON PA66 V2 GRIGIO Ø16	2	PZ	VM1059A1	FILM TERMORETRA IBILE H800	1.350	M	VM1695A0	PERNO POSIZIONE MANIGLIA	2	PZ	VM1916A0	TAPPO COLONNINA SUP DX	1	PZ	VM1917A0	TAPPO COLONNINA SUP SX	1	PZ	VM1918A0	TAPPO COLONNINA INF DX	1	PZ	VM1919A0	TAPPO COLONNINA INF SX	1	PZ	VM1920A0	PIASTRINA DX CHIUSURA VETRO INT	1	PZ	VM1921A0	PIASTRINA SX CHIUSURA VETRO INT	1	PZ	VT1067A0	VETRO ESTERNO GRIGIO 798X344X5 LM ELENA	1	PZ	VT1067A0	VETRO ESTERNO GRIGIO 798X344X5 LM ELENA	1	PZ
Codice	Descrizione	Qtà	UM																																																																										
IP1385A1	IMB POL ANGOLARE 110X80X2000 D30	0.800	M																																																																										
IP1508A1	POLISTIROLO PROFILO AD U 2000X60X60	1.710	M																																																																										
RC1200A0	MOLLA A COMPRESSIO NE DE4 DF0.5 H24	2	PZ																																																																										
SL1050A1	NASTRO BIADESIVO 3M TRANSFER VH	0.660	M																																																																										
TB2306A0	COLONNINA DX LM STE-ELE 40X40X1	1	PZ																																																																										
TB3080A0	COLONNINA SX LM STE-EL	1	PZ																																																																										
VM1025A0	TAPPO NYLON PA66 V2 GRIGIO Ø16	2	PZ																																																																										
VM1059A1	FILM TERMORETRA IBILE H800	1.350	M																																																																										
VM1695A0	PERNO POSIZIONE MANIGLIA	2	PZ																																																																										
VM1916A0	TAPPO COLONNINA SUP DX	1	PZ																																																																										
VM1917A0	TAPPO COLONNINA SUP SX	1	PZ																																																																										
VM1918A0	TAPPO COLONNINA INF DX	1	PZ																																																																										
VM1919A0	TAPPO COLONNINA INF SX	1	PZ																																																																										
VM1920A0	PIASTRINA DX CHIUSURA VETRO INT	1	PZ																																																																										
VM1921A0	PIASTRINA SX CHIUSURA VETRO INT	1	PZ																																																																										
VT1067A0	VETRO ESTERNO GRIGIO 798X344X5 LM ELENA	1	PZ																																																																										
VT1067A0	VETRO ESTERNO GRIGIO 798X344X5 LM ELENA	1	PZ																																																																										

COMPONENTE			RICAMBIO																																																																						
Codice	Descrizione	Immagine	Codice	Descrizione	Lista componenti																																																																				
VM1916A	TAPPO COLONNINA SUP DX		KVT1066A	KIT VETRO ESTERNO LM ELEN	<table border="1"> <thead> <tr> <th>Codice</th> <th>Descrizione</th> <th>Qtà</th> <th>UM</th> </tr> </thead> <tbody> <tr> <td>IP1385A1</td> <td>IMB POL ANGOLARE 110X80X2000 D30</td> <td>0.800</td> <td>M</td> </tr> <tr> <td>IP1508A1</td> <td>POLISTIROLO PROFILO AD U 2000X60X60</td> <td>1.710</td> <td>M</td> </tr> <tr> <td>RC1200A0</td> <td>MOLLA A COMPRESSIO NE DE4 DF0.5 H24</td> <td>2</td> <td>PZ</td> </tr> <tr> <td>SL1050A1</td> <td>NASTRO BIADESIVO 3M TRANSFER VH</td> <td>0.660</td> <td>M</td> </tr> <tr> <td>TB2306A0</td> <td>COLONNINA DX LM STE-ELE 40X40X1</td> <td>2</td> <td>PZ</td> </tr> <tr> <td>VM1025A0</td> <td>TAPPO NYLON PA66 V2 GRIGIO Ø16</td> <td>2</td> <td>PZ</td> </tr> <tr> <td>VM1059A1</td> <td>FILM TERMORETRA IBILE H800</td> <td>1.350</td> <td>M</td> </tr> <tr> <td>VM1695A0</td> <td>PERNO POSIZIONE MANIGLIA</td> <td>2</td> <td>PZ</td> </tr> <tr> <td>VM1916A0</td> <td>TAPPO COLONNINA SUP DX</td> <td>1</td> <td>PZ</td> </tr> <tr> <td>VM1917A0</td> <td>TAPPO COLONNINA SUP SX</td> <td>1</td> <td>PZ</td> </tr> <tr> <td>VM1918A0</td> <td>TAPPO COLONNINA INF DX</td> <td>1</td> <td>PZ</td> </tr> <tr> <td>VM1919A0</td> <td>TAPPO COLONNINA INF SX</td> <td>1</td> <td>PZ</td> </tr> <tr> <td>VM1920A0</td> <td>PIASTRINA DX CHIUSURA VETRO INT</td> <td>1</td> <td>PZ</td> </tr> <tr> <td>VM1921A0</td> <td>PIASTRINA SX CHIUSURA VETRO INT</td> <td>1</td> <td>PZ</td> </tr> <tr> <td>VT1066A2</td> <td>VETRO ESTERNO SER. GIALLO 798X344X5</td> <td>1</td> <td>PZ</td> </tr> <tr> <td>VT1066A2</td> <td>VETRO ESTERNO SER. GIALLO 798X344X5</td> <td>1</td> <td>PZ</td> </tr> </tbody> </table>	Codice	Descrizione	Qtà	UM	IP1385A1	IMB POL ANGOLARE 110X80X2000 D30	0.800	M	IP1508A1	POLISTIROLO PROFILO AD U 2000X60X60	1.710	M	RC1200A0	MOLLA A COMPRESSIO NE DE4 DF0.5 H24	2	PZ	SL1050A1	NASTRO BIADESIVO 3M TRANSFER VH	0.660	M	TB2306A0	COLONNINA DX LM STE-ELE 40X40X1	2	PZ	VM1025A0	TAPPO NYLON PA66 V2 GRIGIO Ø16	2	PZ	VM1059A1	FILM TERMORETRA IBILE H800	1.350	M	VM1695A0	PERNO POSIZIONE MANIGLIA	2	PZ	VM1916A0	TAPPO COLONNINA SUP DX	1	PZ	VM1917A0	TAPPO COLONNINA SUP SX	1	PZ	VM1918A0	TAPPO COLONNINA INF DX	1	PZ	VM1919A0	TAPPO COLONNINA INF SX	1	PZ	VM1920A0	PIASTRINA DX CHIUSURA VETRO INT	1	PZ	VM1921A0	PIASTRINA SX CHIUSURA VETRO INT	1	PZ	VT1066A2	VETRO ESTERNO SER. GIALLO 798X344X5	1	PZ	VT1066A2	VETRO ESTERNO SER. GIALLO 798X344X5	1	PZ
Codice	Descrizione	Qtà	UM																																																																						
IP1385A1	IMB POL ANGOLARE 110X80X2000 D30	0.800	M																																																																						
IP1508A1	POLISTIROLO PROFILO AD U 2000X60X60	1.710	M																																																																						
RC1200A0	MOLLA A COMPRESSIO NE DE4 DF0.5 H24	2	PZ																																																																						
SL1050A1	NASTRO BIADESIVO 3M TRANSFER VH	0.660	M																																																																						
TB2306A0	COLONNINA DX LM STE-ELE 40X40X1	2	PZ																																																																						
VM1025A0	TAPPO NYLON PA66 V2 GRIGIO Ø16	2	PZ																																																																						
VM1059A1	FILM TERMORETRA IBILE H800	1.350	M																																																																						
VM1695A0	PERNO POSIZIONE MANIGLIA	2	PZ																																																																						
VM1916A0	TAPPO COLONNINA SUP DX	1	PZ																																																																						
VM1917A0	TAPPO COLONNINA SUP SX	1	PZ																																																																						
VM1918A0	TAPPO COLONNINA INF DX	1	PZ																																																																						
VM1919A0	TAPPO COLONNINA INF SX	1	PZ																																																																						
VM1920A0	PIASTRINA DX CHIUSURA VETRO INT	1	PZ																																																																						
VM1921A0	PIASTRINA SX CHIUSURA VETRO INT	1	PZ																																																																						
VT1066A2	VETRO ESTERNO SER. GIALLO 798X344X5	1	PZ																																																																						
VT1066A2	VETRO ESTERNO SER. GIALLO 798X344X5	1	PZ																																																																						

COMPONENTE			RICAMBIO																																																																		
Codice	Descrizione	Immagine	Codice	Descrizione	Lista componenti																																																																
VM1916A	TAPPO COLONNINA SUP DX		KVM1916A	KIT TAPPO COLONNINA SUPERIORE DX LM800	<table border="1"> <thead> <tr> <th>Codice</th> <th>Descrizione</th> <th>Qtà</th> <th>UM</th> </tr> </thead> <tbody> <tr> <td>VM1916A0</td> <td>TAPPO COLONNINA SUP DX</td> <td>1</td> <td>PZ</td> </tr> </tbody> </table>	Codice	Descrizione	Qtà	UM	VM1916A0	TAPPO COLONNINA SUP DX	1	PZ																																																								
Codice	Descrizione	Qtà	UM																																																																		
VM1916A0	TAPPO COLONNINA SUP DX	1	PZ																																																																		
VM1920A	PIASTRINA DX CHIUSURA VETRO INT		KVT1253A	KIT VETRO ESTERNO XF-XFT195-EG VT1253A	<table border="1"> <thead> <tr> <th>Codice</th> <th>Descrizione</th> <th>Qtà</th> <th>UM</th> </tr> </thead> <tbody> <tr> <td>IP1235B0</td> <td>IMBALLO POLISTIROLO PIANO</td> <td>1</td> <td>PZ</td> </tr> <tr> <td>RC1200A0</td> <td>MOLLA A COMPRESSIO NE DE4 DF0.5 H24</td> <td>2</td> <td>PZ</td> </tr> <tr> <td>SL1050A1</td> <td>NASTRO BIADESIVO 3M TRANSFER VH</td> <td>0.820</td> <td>M</td> </tr> <tr> <td>TB2301A0</td> <td>COLONNINA DX XVC105E 40X40X1</td> <td>1</td> <td>PZ</td> </tr> <tr> <td>TB3081A0</td> <td>COLONNINA SX LM ARI-RO</td> <td>1</td> <td>PZ</td> </tr> <tr> <td>VM1025A0</td> <td>TAPPO NYLON PA66 V2 GRIGIO Ø16</td> <td>2</td> <td>PZ</td> </tr> <tr> <td>VM1695A0</td> <td>PERNO POSIZIONE MANIGLIA</td> <td>2</td> <td>PZ</td> </tr> <tr> <td>VM1916A0</td> <td>TAPPO COLONNINA SUP DX</td> <td>1</td> <td>PZ</td> </tr> <tr> <td>VM1917A0</td> <td>TAPPO COLONNINA SUP SX</td> <td>1</td> <td>PZ</td> </tr> <tr> <td>VM1918A0</td> <td>TAPPO COLONNINA INF DX</td> <td>1</td> <td>PZ</td> </tr> <tr> <td>VM1919A0</td> <td>TAPPO COLONNINA INF SX</td> <td>1</td> <td>PZ</td> </tr> <tr> <td>VM1920A0</td> <td>PIASTRINA DX CHIUSURA VETRO INT</td> <td>1</td> <td>PZ</td> </tr> <tr> <td>VM1921A0</td> <td>PIASTRINA SX CHIUSURA VETRO INT</td> <td>1</td> <td>PZ</td> </tr> <tr> <td>VT1253A0</td> <td>VETRO EST.XF-XFT 195 NERO ENGEFOOD</td> <td>1</td> <td>PZ</td> </tr> <tr> <td>VT1253A0</td> <td>VETRO EST.XF-XFT 195 NERO ENGEFOOD</td> <td>1</td> <td>PZ</td> </tr> </tbody> </table>	Codice	Descrizione	Qtà	UM	IP1235B0	IMBALLO POLISTIROLO PIANO	1	PZ	RC1200A0	MOLLA A COMPRESSIO NE DE4 DF0.5 H24	2	PZ	SL1050A1	NASTRO BIADESIVO 3M TRANSFER VH	0.820	M	TB2301A0	COLONNINA DX XVC105E 40X40X1	1	PZ	TB3081A0	COLONNINA SX LM ARI-RO	1	PZ	VM1025A0	TAPPO NYLON PA66 V2 GRIGIO Ø16	2	PZ	VM1695A0	PERNO POSIZIONE MANIGLIA	2	PZ	VM1916A0	TAPPO COLONNINA SUP DX	1	PZ	VM1917A0	TAPPO COLONNINA SUP SX	1	PZ	VM1918A0	TAPPO COLONNINA INF DX	1	PZ	VM1919A0	TAPPO COLONNINA INF SX	1	PZ	VM1920A0	PIASTRINA DX CHIUSURA VETRO INT	1	PZ	VM1921A0	PIASTRINA SX CHIUSURA VETRO INT	1	PZ	VT1253A0	VETRO EST.XF-XFT 195 NERO ENGEFOOD	1	PZ	VT1253A0	VETRO EST.XF-XFT 195 NERO ENGEFOOD	1	PZ
Codice	Descrizione	Qtà	UM																																																																		
IP1235B0	IMBALLO POLISTIROLO PIANO	1	PZ																																																																		
RC1200A0	MOLLA A COMPRESSIO NE DE4 DF0.5 H24	2	PZ																																																																		
SL1050A1	NASTRO BIADESIVO 3M TRANSFER VH	0.820	M																																																																		
TB2301A0	COLONNINA DX XVC105E 40X40X1	1	PZ																																																																		
TB3081A0	COLONNINA SX LM ARI-RO	1	PZ																																																																		
VM1025A0	TAPPO NYLON PA66 V2 GRIGIO Ø16	2	PZ																																																																		
VM1695A0	PERNO POSIZIONE MANIGLIA	2	PZ																																																																		
VM1916A0	TAPPO COLONNINA SUP DX	1	PZ																																																																		
VM1917A0	TAPPO COLONNINA SUP SX	1	PZ																																																																		
VM1918A0	TAPPO COLONNINA INF DX	1	PZ																																																																		
VM1919A0	TAPPO COLONNINA INF SX	1	PZ																																																																		
VM1920A0	PIASTRINA DX CHIUSURA VETRO INT	1	PZ																																																																		
VM1921A0	PIASTRINA SX CHIUSURA VETRO INT	1	PZ																																																																		
VT1253A0	VETRO EST.XF-XFT 195 NERO ENGEFOOD	1	PZ																																																																		
VT1253A0	VETRO EST.XF-XFT 195 NERO ENGEFOOD	1	PZ																																																																		

COMPONENTE			RICAMBIO																																																														
Codice	Descrizione	Immagine	Codice	Descrizione	Lista componenti																																																												
VM1920A	PIASTRINA DX CHIUSURA VETRO INT		KVT1252A	KIT VETRO ESTERNO XF135-EG VT1252A	<table border="1"> <thead> <tr> <th>Codice</th> <th>Descrizione</th> <th>Qtà</th> <th>UM</th> </tr> </thead> <tbody> <tr> <td>RC1200A0</td> <td>MOLLA A COMPRESSIO NE DE4 DF0.5 H24</td> <td>2</td> <td>PZ</td> </tr> <tr> <td>SL1050A1</td> <td>NASTRO BIADESIVO 3M TRANSFER VH</td> <td>0.820</td> <td>M</td> </tr> <tr> <td>TB2301A0</td> <td>COLONNINA DX XVC105E 40X40X1</td> <td>1</td> <td>PZ</td> </tr> <tr> <td>TB3081A0</td> <td>COLONNINA SX LM ARI-RO</td> <td>1</td> <td>PZ</td> </tr> <tr> <td>VM1025A0</td> <td>TAPPO NYLON PA66 V2 GRIGIO Ø16</td> <td>2</td> <td>PZ</td> </tr> <tr> <td>VM1695A0</td> <td>PERNO POSIZIONE MANIGLIA</td> <td>2</td> <td>PZ</td> </tr> <tr> <td>VM1920A0</td> <td>PIASTRINA DX CHIUSURA VETRO INT</td> <td>1</td> <td>PZ</td> </tr> <tr> <td>VM1921A0</td> <td>PIASTRINA SX CHIUSURA VETRO INT</td> <td>1</td> <td>PZ</td> </tr> <tr> <td>VM2062A0</td> <td>TAPPO COLONNINA LM600 SUP DX</td> <td>1</td> <td>PZ</td> </tr> <tr> <td>VM2063A0</td> <td>TAPPO COLONNINA LM600 SUP SX</td> <td>1</td> <td>PZ</td> </tr> <tr> <td>VM2064A0</td> <td>TAPPO COLONNINA LM600 INF DX</td> <td>1</td> <td>PZ</td> </tr> <tr> <td>VM2065A0</td> <td>TAPPO COLONNINA LM600 INF SX</td> <td>1</td> <td>PZ</td> </tr> <tr> <td>VT1252A0</td> <td>VETRO EST.XF135 NERO ENGEFOOD</td> <td>1</td> <td>PZ</td> </tr> <tr> <td>VT1252A0</td> <td>VETRO EST.XF135 NERO ENGEFOOD</td> <td>1</td> <td>PZ</td> </tr> </tbody> </table>	Codice	Descrizione	Qtà	UM	RC1200A0	MOLLA A COMPRESSIO NE DE4 DF0.5 H24	2	PZ	SL1050A1	NASTRO BIADESIVO 3M TRANSFER VH	0.820	M	TB2301A0	COLONNINA DX XVC105E 40X40X1	1	PZ	TB3081A0	COLONNINA SX LM ARI-RO	1	PZ	VM1025A0	TAPPO NYLON PA66 V2 GRIGIO Ø16	2	PZ	VM1695A0	PERNO POSIZIONE MANIGLIA	2	PZ	VM1920A0	PIASTRINA DX CHIUSURA VETRO INT	1	PZ	VM1921A0	PIASTRINA SX CHIUSURA VETRO INT	1	PZ	VM2062A0	TAPPO COLONNINA LM600 SUP DX	1	PZ	VM2063A0	TAPPO COLONNINA LM600 SUP SX	1	PZ	VM2064A0	TAPPO COLONNINA LM600 INF DX	1	PZ	VM2065A0	TAPPO COLONNINA LM600 INF SX	1	PZ	VT1252A0	VETRO EST.XF135 NERO ENGEFOOD	1	PZ	VT1252A0	VETRO EST.XF135 NERO ENGEFOOD	1	PZ
Codice	Descrizione	Qtà	UM																																																														
RC1200A0	MOLLA A COMPRESSIO NE DE4 DF0.5 H24	2	PZ																																																														
SL1050A1	NASTRO BIADESIVO 3M TRANSFER VH	0.820	M																																																														
TB2301A0	COLONNINA DX XVC105E 40X40X1	1	PZ																																																														
TB3081A0	COLONNINA SX LM ARI-RO	1	PZ																																																														
VM1025A0	TAPPO NYLON PA66 V2 GRIGIO Ø16	2	PZ																																																														
VM1695A0	PERNO POSIZIONE MANIGLIA	2	PZ																																																														
VM1920A0	PIASTRINA DX CHIUSURA VETRO INT	1	PZ																																																														
VM1921A0	PIASTRINA SX CHIUSURA VETRO INT	1	PZ																																																														
VM2062A0	TAPPO COLONNINA LM600 SUP DX	1	PZ																																																														
VM2063A0	TAPPO COLONNINA LM600 SUP SX	1	PZ																																																														
VM2064A0	TAPPO COLONNINA LM600 INF DX	1	PZ																																																														
VM2065A0	TAPPO COLONNINA LM600 INF SX	1	PZ																																																														
VT1252A0	VETRO EST.XF135 NERO ENGEFOOD	1	PZ																																																														
VT1252A0	VETRO EST.XF135 NERO ENGEFOOD	1	PZ																																																														
			KVT1072A	KIT VETRO ESTERNO LM ROSSELLA BLACK	<table border="1"> <thead> <tr> <th>Codice</th> <th>Descrizione</th> <th>Qtà</th> <th>UM</th> </tr> </thead> <tbody> <tr> <td>IP1385A1</td> <td>IMB POL ANGOLARE 110X80X2000 D30</td> <td>0.960</td> <td>M</td> </tr> <tr> <td>IP1508A1</td> <td>POLISTIROLO PROFILO AD U 2000X60X60</td> <td>1.270</td> <td>M</td> </tr> </tbody> </table>	Codice	Descrizione	Qtà	UM	IP1385A1	IMB POL ANGOLARE 110X80X2000 D30	0.960	M	IP1508A1	POLISTIROLO PROFILO AD U 2000X60X60	1.270	M																																																
Codice	Descrizione	Qtà	UM																																																														
IP1385A1	IMB POL ANGOLARE 110X80X2000 D30	0.960	M																																																														
IP1508A1	POLISTIROLO PROFILO AD U 2000X60X60	1.270	M																																																														

COMPONENTE			RICAMBIO																																																																		
Codice	Descrizione	Immagine	Codice	Descrizione	Lista componenti																																																																
VM1920A	PIASTRINA DX CHIUSURA VETRO INT		KVT1072A	KIT VETRO ESTERNO LM ROSSELLA BLACK	<table border="1"> <thead> <tr> <th>Codice</th> <th>Descrizione</th> <th>Qtà</th> <th>UM</th> </tr> </thead> <tbody> <tr> <td>RC1200A0</td> <td>MOLLA A COMPRESSIO NE DE4 DF0.5 H24</td> <td>2</td> <td>PZ</td> </tr> <tr> <td>SL1050A1</td> <td>NASTRO BIADESIVO 3M TRANSFER VH</td> <td>0.820</td> <td>M</td> </tr> <tr> <td>TB2301A0</td> <td>COLONNINA DX XVC105E 40X40X1</td> <td>1</td> <td>PZ</td> </tr> <tr> <td>TB3081A0</td> <td>COLONNINA SX LM ARI-RO</td> <td>1</td> <td>PZ</td> </tr> <tr> <td>VM1025A0</td> <td>TAPPO NYLON PA66 V2 GRIGIO Ø16</td> <td>2</td> <td>PZ</td> </tr> <tr> <td>VM1059A1</td> <td>FILM TERMORETRA IBILE H800</td> <td>1.300</td> <td>M</td> </tr> <tr> <td>VM1695A0</td> <td>PERNO POSIZIONE MANIGLIA</td> <td>2</td> <td>PZ</td> </tr> <tr> <td>VM1916A0</td> <td>TAPPO COLONNINA SUP DX</td> <td>1</td> <td>PZ</td> </tr> <tr> <td>VM1917A0</td> <td>TAPPO COLONNINA SUP SX</td> <td>1</td> <td>PZ</td> </tr> <tr> <td>VM1918A0</td> <td>TAPPO COLONNINA INF DX</td> <td>1</td> <td>PZ</td> </tr> <tr> <td>VM1919A0</td> <td>TAPPO COLONNINA INF SX</td> <td>1</td> <td>PZ</td> </tr> <tr> <td>VM1920A0</td> <td>PIASTRINA DX CHIUSURA VETRO INT</td> <td>1</td> <td>PZ</td> </tr> <tr> <td>VM1921A0</td> <td>PIASTRINA SX CHIUSURA VETRO INT</td> <td>1</td> <td>PZ</td> </tr> <tr> <td>VT1072A0</td> <td>VETRO EST. 798X424 NERO LMISS ROSSELLA</td> <td>1</td> <td>PZ</td> </tr> <tr> <td>VT1072A0</td> <td>VETRO EST. 798X424 NERO LMISS ROSSELLA</td> <td>1</td> <td>PZ</td> </tr> </tbody> </table>	Codice	Descrizione	Qtà	UM	RC1200A0	MOLLA A COMPRESSIO NE DE4 DF0.5 H24	2	PZ	SL1050A1	NASTRO BIADESIVO 3M TRANSFER VH	0.820	M	TB2301A0	COLONNINA DX XVC105E 40X40X1	1	PZ	TB3081A0	COLONNINA SX LM ARI-RO	1	PZ	VM1025A0	TAPPO NYLON PA66 V2 GRIGIO Ø16	2	PZ	VM1059A1	FILM TERMORETRA IBILE H800	1.300	M	VM1695A0	PERNO POSIZIONE MANIGLIA	2	PZ	VM1916A0	TAPPO COLONNINA SUP DX	1	PZ	VM1917A0	TAPPO COLONNINA SUP SX	1	PZ	VM1918A0	TAPPO COLONNINA INF DX	1	PZ	VM1919A0	TAPPO COLONNINA INF SX	1	PZ	VM1920A0	PIASTRINA DX CHIUSURA VETRO INT	1	PZ	VM1921A0	PIASTRINA SX CHIUSURA VETRO INT	1	PZ	VT1072A0	VETRO EST. 798X424 NERO LMISS ROSSELLA	1	PZ	VT1072A0	VETRO EST. 798X424 NERO LMISS ROSSELLA	1	PZ
Codice	Descrizione	Qtà	UM																																																																		
RC1200A0	MOLLA A COMPRESSIO NE DE4 DF0.5 H24	2	PZ																																																																		
SL1050A1	NASTRO BIADESIVO 3M TRANSFER VH	0.820	M																																																																		
TB2301A0	COLONNINA DX XVC105E 40X40X1	1	PZ																																																																		
TB3081A0	COLONNINA SX LM ARI-RO	1	PZ																																																																		
VM1025A0	TAPPO NYLON PA66 V2 GRIGIO Ø16	2	PZ																																																																		
VM1059A1	FILM TERMORETRA IBILE H800	1.300	M																																																																		
VM1695A0	PERNO POSIZIONE MANIGLIA	2	PZ																																																																		
VM1916A0	TAPPO COLONNINA SUP DX	1	PZ																																																																		
VM1917A0	TAPPO COLONNINA SUP SX	1	PZ																																																																		
VM1918A0	TAPPO COLONNINA INF DX	1	PZ																																																																		
VM1919A0	TAPPO COLONNINA INF SX	1	PZ																																																																		
VM1920A0	PIASTRINA DX CHIUSURA VETRO INT	1	PZ																																																																		
VM1921A0	PIASTRINA SX CHIUSURA VETRO INT	1	PZ																																																																		
VT1072A0	VETRO EST. 798X424 NERO LMISS ROSSELLA	1	PZ																																																																		
VT1072A0	VETRO EST. 798X424 NERO LMISS ROSSELLA	1	PZ																																																																		
			KVT1071A	KIT VETRO ESTERNO LM ROSSELLA	<table border="1"> <thead> <tr> <th>Codice</th> <th>Descrizione</th> <th>Qtà</th> <th>UM</th> </tr> </thead> <tbody> <tr> <td>IP1385A1</td> <td>IMB POL ANGOLARE 110X80X2000 D30</td> <td>0.960</td> <td>M</td> </tr> </tbody> </table>	Codice	Descrizione	Qtà	UM	IP1385A1	IMB POL ANGOLARE 110X80X2000 D30	0.960	M																																																								
Codice	Descrizione	Qtà	UM																																																																		
IP1385A1	IMB POL ANGOLARE 110X80X2000 D30	0.960	M																																																																		

COMPONENTE			RICAMBIO																																																																		
Codice	Descrizione	Immagine	Codice	Descrizione	Lista componenti																																																																
VM1920A	PIASTRINA DX CHIUSURA VETRO INT		KVT1071A	KIT VETRO ESTERNO LM ROSSELLA	<table border="1"> <thead> <tr> <th>Codice</th> <th>Descrizione</th> <th>Qtà</th> <th>UM</th> </tr> </thead> <tbody> <tr> <td>IP1508A1</td> <td>POLISTIROLO PROFILO AD U 2000X60X60</td> <td>1.300</td> <td>M</td> </tr> <tr> <td>RC1200A0</td> <td>MOLLA A COMPRESSIO NE DE4 DF0.5 H24</td> <td>2</td> <td>PZ</td> </tr> <tr> <td>SL1050A1</td> <td>NASTRO BIADESIVO 3M TRANSFER VH</td> <td>0.820</td> <td>M</td> </tr> <tr> <td>TB2301A0</td> <td>COLONNINA DX XVC105E 40X40X1</td> <td>2</td> <td>PZ</td> </tr> <tr> <td>VM1025A0</td> <td>TAPPO NYLON PA66 V2 GRIGIO Ø16</td> <td>2</td> <td>PZ</td> </tr> <tr> <td>VM1059A1</td> <td>FILM TERMORETRA IBILE H800</td> <td>1.350</td> <td>M</td> </tr> <tr> <td>VM1695A0</td> <td>PERNO POSIZIONE MANIGLIA</td> <td>2</td> <td>PZ</td> </tr> <tr> <td>VM1916A0</td> <td>TAPPO COLONNINA SUP DX</td> <td>1</td> <td>PZ</td> </tr> <tr> <td>VM1917A0</td> <td>TAPPO COLONNINA SUP SX</td> <td>1</td> <td>PZ</td> </tr> <tr> <td>VM1918A0</td> <td>TAPPO COLONNINA INF DX</td> <td>1</td> <td>PZ</td> </tr> <tr> <td>VM1919A0</td> <td>TAPPO COLONNINA INF SX</td> <td>1</td> <td>PZ</td> </tr> <tr> <td>VM1920A0</td> <td>PIASTRINA DX CHIUSURA VETRO INT</td> <td>1</td> <td>PZ</td> </tr> <tr> <td>VM1921A0</td> <td>PIASTRINA SX CHIUSURA VETRO INT</td> <td>1</td> <td>PZ</td> </tr> <tr> <td>VT1071A2</td> <td>VETRO ESTERNO SER. GIALLO 798X424X5</td> <td>1</td> <td>PZ</td> </tr> <tr> <td>VT1071A2</td> <td>VETRO ESTERNO SER. GIALLO 798X424X5</td> <td>1</td> <td>PZ</td> </tr> </tbody> </table>	Codice	Descrizione	Qtà	UM	IP1508A1	POLISTIROLO PROFILO AD U 2000X60X60	1.300	M	RC1200A0	MOLLA A COMPRESSIO NE DE4 DF0.5 H24	2	PZ	SL1050A1	NASTRO BIADESIVO 3M TRANSFER VH	0.820	M	TB2301A0	COLONNINA DX XVC105E 40X40X1	2	PZ	VM1025A0	TAPPO NYLON PA66 V2 GRIGIO Ø16	2	PZ	VM1059A1	FILM TERMORETRA IBILE H800	1.350	M	VM1695A0	PERNO POSIZIONE MANIGLIA	2	PZ	VM1916A0	TAPPO COLONNINA SUP DX	1	PZ	VM1917A0	TAPPO COLONNINA SUP SX	1	PZ	VM1918A0	TAPPO COLONNINA INF DX	1	PZ	VM1919A0	TAPPO COLONNINA INF SX	1	PZ	VM1920A0	PIASTRINA DX CHIUSURA VETRO INT	1	PZ	VM1921A0	PIASTRINA SX CHIUSURA VETRO INT	1	PZ	VT1071A2	VETRO ESTERNO SER. GIALLO 798X424X5	1	PZ	VT1071A2	VETRO ESTERNO SER. GIALLO 798X424X5	1	PZ
Codice	Descrizione	Qtà	UM																																																																		
IP1508A1	POLISTIROLO PROFILO AD U 2000X60X60	1.300	M																																																																		
RC1200A0	MOLLA A COMPRESSIO NE DE4 DF0.5 H24	2	PZ																																																																		
SL1050A1	NASTRO BIADESIVO 3M TRANSFER VH	0.820	M																																																																		
TB2301A0	COLONNINA DX XVC105E 40X40X1	2	PZ																																																																		
VM1025A0	TAPPO NYLON PA66 V2 GRIGIO Ø16	2	PZ																																																																		
VM1059A1	FILM TERMORETRA IBILE H800	1.350	M																																																																		
VM1695A0	PERNO POSIZIONE MANIGLIA	2	PZ																																																																		
VM1916A0	TAPPO COLONNINA SUP DX	1	PZ																																																																		
VM1917A0	TAPPO COLONNINA SUP SX	1	PZ																																																																		
VM1918A0	TAPPO COLONNINA INF DX	1	PZ																																																																		
VM1919A0	TAPPO COLONNINA INF SX	1	PZ																																																																		
VM1920A0	PIASTRINA DX CHIUSURA VETRO INT	1	PZ																																																																		
VM1921A0	PIASTRINA SX CHIUSURA VETRO INT	1	PZ																																																																		
VT1071A2	VETRO ESTERNO SER. GIALLO 798X424X5	1	PZ																																																																		
VT1071A2	VETRO ESTERNO SER. GIALLO 798X424X5	1	PZ																																																																		
			KVT1067A	KIT VETRO ESTERNO LM ELENA BLACK	<table border="1"> <thead> <tr> <th>Codice</th> <th>Descrizione</th> <th>Qtà</th> <th>UM</th> </tr> </thead> <tbody> <tr> <td>IP1385A1</td> <td>IMB POL ANGOLARE 110X80X2000 D30</td> <td>0.800</td> <td>M</td> </tr> </tbody> </table>	Codice	Descrizione	Qtà	UM	IP1385A1	IMB POL ANGOLARE 110X80X2000 D30	0.800	M																																																								
Codice	Descrizione	Qtà	UM																																																																		
IP1385A1	IMB POL ANGOLARE 110X80X2000 D30	0.800	M																																																																		

COMPONENTE			RICAMBIO																																																																						
Codice	Descrizione	Immagine	Codice	Descrizione	Lista componenti																																																																				
VM1920A	PIASTRINA DX CHIUSURA VETRO INT		KVT1067A	KIT VETRO ESTERNO LM ELENA BLACK	<table border="1"> <thead> <tr> <th>Codice</th> <th>Descrizione</th> <th>Qtà</th> <th>UM</th> </tr> </thead> <tbody> <tr> <td>IP1508A1</td> <td>POLISTIROLO PROFILO AD U 2000X60X60</td> <td>1.710</td> <td>M</td> </tr> <tr> <td>RC1200A0</td> <td>MOLLA A COMPRESSIO NE DE4 DF0.5 H24</td> <td>2</td> <td>PZ</td> </tr> <tr> <td>SL1050A1</td> <td>NASTRO BIADESIVO 3M TRANSFER VH</td> <td>0.660</td> <td>M</td> </tr> <tr> <td>TB2306A0</td> <td>COLONNINA DX LM STE-ELE 40X40X1</td> <td>1</td> <td>PZ</td> </tr> <tr> <td>TB3080A0</td> <td>COLONNINA SX LM STE-EL</td> <td>1</td> <td>PZ</td> </tr> <tr> <td>VM1025A0</td> <td>TAPPO NYLON PA66 V2 GRIGIO Ø16</td> <td>2</td> <td>PZ</td> </tr> <tr> <td>VM1059A1</td> <td>FILM TERMORETRA IBILE H800</td> <td>1.350</td> <td>M</td> </tr> <tr> <td>VM1695A0</td> <td>PERNO POSIZIONE MANIGLIA</td> <td>2</td> <td>PZ</td> </tr> <tr> <td>VM1916A0</td> <td>TAPPO COLONNINA SUP DX</td> <td>1</td> <td>PZ</td> </tr> <tr> <td>VM1917A0</td> <td>TAPPO COLONNINA SUP SX</td> <td>1</td> <td>PZ</td> </tr> <tr> <td>VM1918A0</td> <td>TAPPO COLONNINA INF DX</td> <td>1</td> <td>PZ</td> </tr> <tr> <td>VM1919A0</td> <td>TAPPO COLONNINA INF SX</td> <td>1</td> <td>PZ</td> </tr> <tr> <td>VM1920A0</td> <td>PIASTRINA DX CHIUSURA VETRO INT</td> <td>1</td> <td>PZ</td> </tr> <tr> <td>VM1921A0</td> <td>PIASTRINA SX CHIUSURA VETRO INT</td> <td>1</td> <td>PZ</td> </tr> <tr> <td>VT1067A0</td> <td>VETRO ESTERNO GRIGIO 798X344X5 LM ELENA</td> <td>1</td> <td>PZ</td> </tr> <tr> <td>VT1067A0</td> <td>VETRO ESTERNO GRIGIO 798X344X5 LM ELENA</td> <td>1</td> <td>PZ</td> </tr> </tbody> </table>	Codice	Descrizione	Qtà	UM	IP1508A1	POLISTIROLO PROFILO AD U 2000X60X60	1.710	M	RC1200A0	MOLLA A COMPRESSIO NE DE4 DF0.5 H24	2	PZ	SL1050A1	NASTRO BIADESIVO 3M TRANSFER VH	0.660	M	TB2306A0	COLONNINA DX LM STE-ELE 40X40X1	1	PZ	TB3080A0	COLONNINA SX LM STE-EL	1	PZ	VM1025A0	TAPPO NYLON PA66 V2 GRIGIO Ø16	2	PZ	VM1059A1	FILM TERMORETRA IBILE H800	1.350	M	VM1695A0	PERNO POSIZIONE MANIGLIA	2	PZ	VM1916A0	TAPPO COLONNINA SUP DX	1	PZ	VM1917A0	TAPPO COLONNINA SUP SX	1	PZ	VM1918A0	TAPPO COLONNINA INF DX	1	PZ	VM1919A0	TAPPO COLONNINA INF SX	1	PZ	VM1920A0	PIASTRINA DX CHIUSURA VETRO INT	1	PZ	VM1921A0	PIASTRINA SX CHIUSURA VETRO INT	1	PZ	VT1067A0	VETRO ESTERNO GRIGIO 798X344X5 LM ELENA	1	PZ	VT1067A0	VETRO ESTERNO GRIGIO 798X344X5 LM ELENA	1	PZ
Codice	Descrizione	Qtà	UM																																																																						
IP1508A1	POLISTIROLO PROFILO AD U 2000X60X60	1.710	M																																																																						
RC1200A0	MOLLA A COMPRESSIO NE DE4 DF0.5 H24	2	PZ																																																																						
SL1050A1	NASTRO BIADESIVO 3M TRANSFER VH	0.660	M																																																																						
TB2306A0	COLONNINA DX LM STE-ELE 40X40X1	1	PZ																																																																						
TB3080A0	COLONNINA SX LM STE-EL	1	PZ																																																																						
VM1025A0	TAPPO NYLON PA66 V2 GRIGIO Ø16	2	PZ																																																																						
VM1059A1	FILM TERMORETRA IBILE H800	1.350	M																																																																						
VM1695A0	PERNO POSIZIONE MANIGLIA	2	PZ																																																																						
VM1916A0	TAPPO COLONNINA SUP DX	1	PZ																																																																						
VM1917A0	TAPPO COLONNINA SUP SX	1	PZ																																																																						
VM1918A0	TAPPO COLONNINA INF DX	1	PZ																																																																						
VM1919A0	TAPPO COLONNINA INF SX	1	PZ																																																																						
VM1920A0	PIASTRINA DX CHIUSURA VETRO INT	1	PZ																																																																						
VM1921A0	PIASTRINA SX CHIUSURA VETRO INT	1	PZ																																																																						
VT1067A0	VETRO ESTERNO GRIGIO 798X344X5 LM ELENA	1	PZ																																																																						
VT1067A0	VETRO ESTERNO GRIGIO 798X344X5 LM ELENA	1	PZ																																																																						

COMPONENTE			RICAMBIO																																																																						
Codice	Descrizione	Immagine	Codice	Descrizione	Lista componenti																																																																				
VM1920A	PIASTRINA DX CHIUSURA VETRO INT		KVT1066A	KIT VETRO ESTERNO LM ELEN	<table border="1"> <thead> <tr> <th>Codice</th> <th>Descrizione</th> <th>Qtà</th> <th>UM</th> </tr> </thead> <tbody> <tr> <td>IP1385A1</td> <td>IMB POL ANGOLARE 110X80X2000 D30</td> <td>0.800</td> <td>M</td> </tr> <tr> <td>IP1508A1</td> <td>POLISTIROLO PROFILO AD U 2000X60X60</td> <td>1.710</td> <td>M</td> </tr> <tr> <td>RC1200A0</td> <td>MOLLA A COMPRESSIO NE DE4 DF0.5 H24</td> <td>2</td> <td>PZ</td> </tr> <tr> <td>SL1050A1</td> <td>NASTRO BIADESIVO 3M TRANSFER VH</td> <td>0.660</td> <td>M</td> </tr> <tr> <td>TB2306A0</td> <td>COLONNINA DX LM STE-ELE 40X40X1</td> <td>2</td> <td>PZ</td> </tr> <tr> <td>VM1025A0</td> <td>TAPPO NYLON PA66 V2 GRIGIO Ø16</td> <td>2</td> <td>PZ</td> </tr> <tr> <td>VM1059A1</td> <td>FILM TERMORETRA IBILE H800</td> <td>1.350</td> <td>M</td> </tr> <tr> <td>VM1695A0</td> <td>PERNO POSIZIONE MANIGLIA</td> <td>2</td> <td>PZ</td> </tr> <tr> <td>VM1916A0</td> <td>TAPPO COLONNINA SUP DX</td> <td>1</td> <td>PZ</td> </tr> <tr> <td>VM1917A0</td> <td>TAPPO COLONNINA SUP SX</td> <td>1</td> <td>PZ</td> </tr> <tr> <td>VM1918A0</td> <td>TAPPO COLONNINA INF DX</td> <td>1</td> <td>PZ</td> </tr> <tr> <td>VM1919A0</td> <td>TAPPO COLONNINA INF SX</td> <td>1</td> <td>PZ</td> </tr> <tr> <td>VM1920A0</td> <td>PIASTRINA DX CHIUSURA VETRO INT</td> <td>1</td> <td>PZ</td> </tr> <tr> <td>VM1921A0</td> <td>PIASTRINA SX CHIUSURA VETRO INT</td> <td>1</td> <td>PZ</td> </tr> <tr> <td>VT1066A2</td> <td>VETRO ESTERNO SER. GIALLO 798X344X5</td> <td>1</td> <td>PZ</td> </tr> <tr> <td>VT1066A2</td> <td>VETRO ESTERNO SER. GIALLO 798X344X5</td> <td>1</td> <td>PZ</td> </tr> </tbody> </table>	Codice	Descrizione	Qtà	UM	IP1385A1	IMB POL ANGOLARE 110X80X2000 D30	0.800	M	IP1508A1	POLISTIROLO PROFILO AD U 2000X60X60	1.710	M	RC1200A0	MOLLA A COMPRESSIO NE DE4 DF0.5 H24	2	PZ	SL1050A1	NASTRO BIADESIVO 3M TRANSFER VH	0.660	M	TB2306A0	COLONNINA DX LM STE-ELE 40X40X1	2	PZ	VM1025A0	TAPPO NYLON PA66 V2 GRIGIO Ø16	2	PZ	VM1059A1	FILM TERMORETRA IBILE H800	1.350	M	VM1695A0	PERNO POSIZIONE MANIGLIA	2	PZ	VM1916A0	TAPPO COLONNINA SUP DX	1	PZ	VM1917A0	TAPPO COLONNINA SUP SX	1	PZ	VM1918A0	TAPPO COLONNINA INF DX	1	PZ	VM1919A0	TAPPO COLONNINA INF SX	1	PZ	VM1920A0	PIASTRINA DX CHIUSURA VETRO INT	1	PZ	VM1921A0	PIASTRINA SX CHIUSURA VETRO INT	1	PZ	VT1066A2	VETRO ESTERNO SER. GIALLO 798X344X5	1	PZ	VT1066A2	VETRO ESTERNO SER. GIALLO 798X344X5	1	PZ
Codice	Descrizione	Qtà	UM																																																																						
IP1385A1	IMB POL ANGOLARE 110X80X2000 D30	0.800	M																																																																						
IP1508A1	POLISTIROLO PROFILO AD U 2000X60X60	1.710	M																																																																						
RC1200A0	MOLLA A COMPRESSIO NE DE4 DF0.5 H24	2	PZ																																																																						
SL1050A1	NASTRO BIADESIVO 3M TRANSFER VH	0.660	M																																																																						
TB2306A0	COLONNINA DX LM STE-ELE 40X40X1	2	PZ																																																																						
VM1025A0	TAPPO NYLON PA66 V2 GRIGIO Ø16	2	PZ																																																																						
VM1059A1	FILM TERMORETRA IBILE H800	1.350	M																																																																						
VM1695A0	PERNO POSIZIONE MANIGLIA	2	PZ																																																																						
VM1916A0	TAPPO COLONNINA SUP DX	1	PZ																																																																						
VM1917A0	TAPPO COLONNINA SUP SX	1	PZ																																																																						
VM1918A0	TAPPO COLONNINA INF DX	1	PZ																																																																						
VM1919A0	TAPPO COLONNINA INF SX	1	PZ																																																																						
VM1920A0	PIASTRINA DX CHIUSURA VETRO INT	1	PZ																																																																						
VM1921A0	PIASTRINA SX CHIUSURA VETRO INT	1	PZ																																																																						
VT1066A2	VETRO ESTERNO SER. GIALLO 798X344X5	1	PZ																																																																						
VT1066A2	VETRO ESTERNO SER. GIALLO 798X344X5	1	PZ																																																																						

COMPONENTE			RICAMBIO																																																																														
Codice	Descrizione	Immagine	Codice	Descrizione	Lista componenti																																																																												
VM1920A	PIASTRINA DX CHIUSURA VETRO INT		KVT1063A	KIT VETRO ESTERNO LMISS ARIANNA FORNETTI	<table border="1"> <thead> <tr> <th>Codice</th> <th>Descrizione</th> <th>Qtà</th> <th>UM</th> </tr> </thead> <tbody> <tr> <td>IP1385A1</td> <td>IMB POL ANGOLARE 110X80X2000 D30</td> <td>0.980</td> <td>M</td> </tr> <tr> <td>IP1508A1</td> <td>POLISTIROLO PROFILO AD U 2000X60X60</td> <td>0.960</td> <td>M</td> </tr> <tr> <td>MS1009A0</td> <td>ETICHETTA LOGO FORNETTI</td> <td>1</td> <td>PZ</td> </tr> <tr> <td>RC1200A0</td> <td>MOLLA A COMPRESSIO NE DE4 DF0.5 H24</td> <td>2</td> <td>PZ</td> </tr> <tr> <td>SL1050A1</td> <td>NASTRO BIADESIVO 3M TRANSFER VH</td> <td>0.820</td> <td>M</td> </tr> <tr> <td>TB2301A0</td> <td>COLONNINA DX XVC105E 40X40X1</td> <td>1</td> <td>PZ</td> </tr> <tr> <td>TB3081A0</td> <td>COLONNINA SX LM ARI-RO</td> <td>1</td> <td>PZ</td> </tr> <tr> <td>VM1025A0</td> <td>TAPPO NYLON PA66 V2 GRIGIO Ø16</td> <td>2</td> <td>PZ</td> </tr> <tr> <td>VM1059A1</td> <td>FILM TERMORETRA IBILE H800</td> <td>1.300</td> <td>M</td> </tr> <tr> <td>VM1695A0</td> <td>PERNO POSIZIONE MANIGLIA</td> <td>2</td> <td>PZ</td> </tr> <tr> <td>VM1920A0</td> <td>PIASTRINA DX CHIUSURA VETRO INT</td> <td>1</td> <td>PZ</td> </tr> <tr> <td>VM1921A0</td> <td>PIASTRINA SX CHIUSURA VETRO INT</td> <td>1</td> <td>PZ</td> </tr> <tr> <td>VM2062A0</td> <td>TAPPO COLONNINA LM600 SUP DX</td> <td>1</td> <td>PZ</td> </tr> <tr> <td>VM2063A0</td> <td>TAPPO COLONNINA LM600 SUP SX</td> <td>1</td> <td>PZ</td> </tr> <tr> <td>VM2064A0</td> <td>TAPPO COLONNINA LM600 INF DX</td> <td>1</td> <td>PZ</td> </tr> <tr> <td>VM2065A0</td> <td>TAPPO COLONNINA LM600 INF SX</td> <td>1</td> <td>PZ</td> </tr> <tr> <td>VT1063A0</td> <td>VETRO EST. 598X424 XF135F</td> <td>1</td> <td>PZ</td> </tr> <tr> <td>VT1063A0</td> <td>VETRO EST. 598X424 XF135F</td> <td>1</td> <td>PZ</td> </tr> </tbody> </table>	Codice	Descrizione	Qtà	UM	IP1385A1	IMB POL ANGOLARE 110X80X2000 D30	0.980	M	IP1508A1	POLISTIROLO PROFILO AD U 2000X60X60	0.960	M	MS1009A0	ETICHETTA LOGO FORNETTI	1	PZ	RC1200A0	MOLLA A COMPRESSIO NE DE4 DF0.5 H24	2	PZ	SL1050A1	NASTRO BIADESIVO 3M TRANSFER VH	0.820	M	TB2301A0	COLONNINA DX XVC105E 40X40X1	1	PZ	TB3081A0	COLONNINA SX LM ARI-RO	1	PZ	VM1025A0	TAPPO NYLON PA66 V2 GRIGIO Ø16	2	PZ	VM1059A1	FILM TERMORETRA IBILE H800	1.300	M	VM1695A0	PERNO POSIZIONE MANIGLIA	2	PZ	VM1920A0	PIASTRINA DX CHIUSURA VETRO INT	1	PZ	VM1921A0	PIASTRINA SX CHIUSURA VETRO INT	1	PZ	VM2062A0	TAPPO COLONNINA LM600 SUP DX	1	PZ	VM2063A0	TAPPO COLONNINA LM600 SUP SX	1	PZ	VM2064A0	TAPPO COLONNINA LM600 INF DX	1	PZ	VM2065A0	TAPPO COLONNINA LM600 INF SX	1	PZ	VT1063A0	VETRO EST. 598X424 XF135F	1	PZ	VT1063A0	VETRO EST. 598X424 XF135F	1	PZ
Codice	Descrizione	Qtà	UM																																																																														
IP1385A1	IMB POL ANGOLARE 110X80X2000 D30	0.980	M																																																																														
IP1508A1	POLISTIROLO PROFILO AD U 2000X60X60	0.960	M																																																																														
MS1009A0	ETICHETTA LOGO FORNETTI	1	PZ																																																																														
RC1200A0	MOLLA A COMPRESSIO NE DE4 DF0.5 H24	2	PZ																																																																														
SL1050A1	NASTRO BIADESIVO 3M TRANSFER VH	0.820	M																																																																														
TB2301A0	COLONNINA DX XVC105E 40X40X1	1	PZ																																																																														
TB3081A0	COLONNINA SX LM ARI-RO	1	PZ																																																																														
VM1025A0	TAPPO NYLON PA66 V2 GRIGIO Ø16	2	PZ																																																																														
VM1059A1	FILM TERMORETRA IBILE H800	1.300	M																																																																														
VM1695A0	PERNO POSIZIONE MANIGLIA	2	PZ																																																																														
VM1920A0	PIASTRINA DX CHIUSURA VETRO INT	1	PZ																																																																														
VM1921A0	PIASTRINA SX CHIUSURA VETRO INT	1	PZ																																																																														
VM2062A0	TAPPO COLONNINA LM600 SUP DX	1	PZ																																																																														
VM2063A0	TAPPO COLONNINA LM600 SUP SX	1	PZ																																																																														
VM2064A0	TAPPO COLONNINA LM600 INF DX	1	PZ																																																																														
VM2065A0	TAPPO COLONNINA LM600 INF SX	1	PZ																																																																														
VT1063A0	VETRO EST. 598X424 XF135F	1	PZ																																																																														
VT1063A0	VETRO EST. 598X424 XF135F	1	PZ																																																																														

COMPONENTE			RICAMBIO																																																																						
Codice	Descrizione	Immagine	Codice	Descrizione	Lista componenti																																																																				
VM1920A	PIASTRINA DX CHIUSURA VETRO INT		KVT1062A	KIT VETRO ESTERNO LM ARIANNA BLACK	<table border="1"> <thead> <tr> <th>Codice</th> <th>Descrizione</th> <th>Qtà</th> <th>UM</th> </tr> </thead> <tbody> <tr> <td>IP1385A1</td> <td>IMB POL ANGOLARE 110X80X2000 D30</td> <td>1.280</td> <td>M</td> </tr> <tr> <td>RC1200A0</td> <td>MOLLA A COMPRESSIO NE DE4 DF0.5 H24</td> <td>2</td> <td>PZ</td> </tr> <tr> <td>SL1050A1</td> <td>NASTRO BIADESIVO 3M TRANSFER VH</td> <td>0.820</td> <td>M</td> </tr> <tr> <td>TB2301A0</td> <td>COLONNINA DX XVC105E 40X40X1</td> <td>1</td> <td>PZ</td> </tr> <tr> <td>TB3081A0</td> <td>COLONNINA SX LM ARI-RO</td> <td>1</td> <td>PZ</td> </tr> <tr> <td>VM1025A0</td> <td>TAPPO NYLON PA66 V2 GRIGIO Ø16</td> <td>2</td> <td>PZ</td> </tr> <tr> <td>VM1059A1</td> <td>FILM TERMORETRA IBILE H800</td> <td>1</td> <td>M</td> </tr> <tr> <td>VM1695A0</td> <td>PERNO POSIZIONE MANIGLIA</td> <td>2</td> <td>PZ</td> </tr> <tr> <td>VM1920A0</td> <td>PIASTRINA DX CHIUSURA VETRO INT</td> <td>1</td> <td>PZ</td> </tr> <tr> <td>VM1921A0</td> <td>PIASTRINA SX CHIUSURA VETRO INT</td> <td>1</td> <td>PZ</td> </tr> <tr> <td>VM2062A0</td> <td>TAPPO COLONNINA LM600 SUP DX</td> <td>1</td> <td>PZ</td> </tr> <tr> <td>VM2063A0</td> <td>TAPPO COLONNINA LM600 SUP SX</td> <td>1</td> <td>PZ</td> </tr> <tr> <td>VM2064A0</td> <td>TAPPO COLONNINA LM600 INF DX</td> <td>1</td> <td>PZ</td> </tr> <tr> <td>VM2065A0</td> <td>TAPPO COLONNINA LM600 INF SX</td> <td>1</td> <td>PZ</td> </tr> <tr> <td>VT1062A0</td> <td>VETRO ESTERNO GRIGIO LINEMISS ARIANNA</td> <td>1</td> <td>PZ</td> </tr> <tr> <td>VT1062A0</td> <td>VETRO ESTERNO GRIGIO LINEMISS ARIANNA</td> <td>1</td> <td>PZ</td> </tr> </tbody> </table>	Codice	Descrizione	Qtà	UM	IP1385A1	IMB POL ANGOLARE 110X80X2000 D30	1.280	M	RC1200A0	MOLLA A COMPRESSIO NE DE4 DF0.5 H24	2	PZ	SL1050A1	NASTRO BIADESIVO 3M TRANSFER VH	0.820	M	TB2301A0	COLONNINA DX XVC105E 40X40X1	1	PZ	TB3081A0	COLONNINA SX LM ARI-RO	1	PZ	VM1025A0	TAPPO NYLON PA66 V2 GRIGIO Ø16	2	PZ	VM1059A1	FILM TERMORETRA IBILE H800	1	M	VM1695A0	PERNO POSIZIONE MANIGLIA	2	PZ	VM1920A0	PIASTRINA DX CHIUSURA VETRO INT	1	PZ	VM1921A0	PIASTRINA SX CHIUSURA VETRO INT	1	PZ	VM2062A0	TAPPO COLONNINA LM600 SUP DX	1	PZ	VM2063A0	TAPPO COLONNINA LM600 SUP SX	1	PZ	VM2064A0	TAPPO COLONNINA LM600 INF DX	1	PZ	VM2065A0	TAPPO COLONNINA LM600 INF SX	1	PZ	VT1062A0	VETRO ESTERNO GRIGIO LINEMISS ARIANNA	1	PZ	VT1062A0	VETRO ESTERNO GRIGIO LINEMISS ARIANNA	1	PZ
Codice	Descrizione	Qtà	UM																																																																						
IP1385A1	IMB POL ANGOLARE 110X80X2000 D30	1.280	M																																																																						
RC1200A0	MOLLA A COMPRESSIO NE DE4 DF0.5 H24	2	PZ																																																																						
SL1050A1	NASTRO BIADESIVO 3M TRANSFER VH	0.820	M																																																																						
TB2301A0	COLONNINA DX XVC105E 40X40X1	1	PZ																																																																						
TB3081A0	COLONNINA SX LM ARI-RO	1	PZ																																																																						
VM1025A0	TAPPO NYLON PA66 V2 GRIGIO Ø16	2	PZ																																																																						
VM1059A1	FILM TERMORETRA IBILE H800	1	M																																																																						
VM1695A0	PERNO POSIZIONE MANIGLIA	2	PZ																																																																						
VM1920A0	PIASTRINA DX CHIUSURA VETRO INT	1	PZ																																																																						
VM1921A0	PIASTRINA SX CHIUSURA VETRO INT	1	PZ																																																																						
VM2062A0	TAPPO COLONNINA LM600 SUP DX	1	PZ																																																																						
VM2063A0	TAPPO COLONNINA LM600 SUP SX	1	PZ																																																																						
VM2064A0	TAPPO COLONNINA LM600 INF DX	1	PZ																																																																						
VM2065A0	TAPPO COLONNINA LM600 INF SX	1	PZ																																																																						
VT1062A0	VETRO ESTERNO GRIGIO LINEMISS ARIANNA	1	PZ																																																																						
VT1062A0	VETRO ESTERNO GRIGIO LINEMISS ARIANNA	1	PZ																																																																						

COMPONENTE			RICAMBIO																																																																													
Codice	Descrizione	Immagine	Codice	Descrizione	Lista componenti																																																																											
VM1920A	PIASTRINA DX CHIUSURA VETRO INT		KVT1061A	KIT VETRO ESTERNO LM ARIANNA	<table border="1"> <thead> <tr> <th>Codice</th> <th>Descrizione</th> <th>Qtà</th> <th>UM</th> </tr> </thead> <tbody> <tr> <td>IP1385A1</td> <td>IMB POL ANGOLARE 110X80X2000 D30</td> <td>1.280</td> <td>M</td> </tr> <tr> <td>RC1200A0</td> <td>MOLLA A COMPRESSIO NE DE4 DF0.5 H24</td> <td>2</td> <td>PZ</td> </tr> <tr> <td>SL1050A1</td> <td>NASTRO BIADESIVO 3M TRANSFER VH</td> <td>0.820</td> <td>M</td> </tr> <tr> <td>TB2301A0</td> <td>COLONNINA DX XVC105E 40X40X1</td> <td>2</td> <td>PZ</td> </tr> <tr> <td>VM1025A0</td> <td>TAPPO NYLON PA66 V2 GRIGIO Ø16</td> <td>2</td> <td>PZ</td> </tr> <tr> <td>VM1059A1</td> <td>FILM TERMORETRA IBILE H800</td> <td>1.300</td> <td>M</td> </tr> <tr> <td>VM1695A0</td> <td>PERNO POSIZIONE MANIGLIA</td> <td>2</td> <td>PZ</td> </tr> <tr> <td>VM1920A0</td> <td>PIASTRINA DX CHIUSURA VETRO INT</td> <td>1</td> <td>PZ</td> </tr> <tr> <td>VM1921A0</td> <td>PIASTRINA SX CHIUSURA VETRO INT</td> <td>1</td> <td>PZ</td> </tr> <tr> <td>VM2062A0</td> <td>TAPPO COLONNINA LM600 SUP DX</td> <td>1</td> <td>PZ</td> </tr> <tr> <td>VM2063A0</td> <td>TAPPO COLONNINA LM600 SUP SX</td> <td>1</td> <td>PZ</td> </tr> <tr> <td>VM2064A0</td> <td>TAPPO COLONNINA LM600 INF DX</td> <td>1</td> <td>PZ</td> </tr> <tr> <td>VM2065A0</td> <td>TAPPO COLONNINA LM600 INF SX</td> <td>1</td> <td>PZ</td> </tr> <tr> <td>VT1061A2</td> <td>VETRO ESTERNO SER. GIALLO 598X424X5</td> <td>1</td> <td>PZ</td> </tr> <tr> <td>VT1061A2</td> <td>VETRO ESTERNO SER. GIALLO 598X424X5</td> <td>1</td> <td>PZ</td> </tr> </tbody> </table>	Codice	Descrizione	Qtà	UM	IP1385A1	IMB POL ANGOLARE 110X80X2000 D30	1.280	M	RC1200A0	MOLLA A COMPRESSIO NE DE4 DF0.5 H24	2	PZ	SL1050A1	NASTRO BIADESIVO 3M TRANSFER VH	0.820	M	TB2301A0	COLONNINA DX XVC105E 40X40X1	2	PZ	VM1025A0	TAPPO NYLON PA66 V2 GRIGIO Ø16	2	PZ	VM1059A1	FILM TERMORETRA IBILE H800	1.300	M	VM1695A0	PERNO POSIZIONE MANIGLIA	2	PZ	VM1920A0	PIASTRINA DX CHIUSURA VETRO INT	1	PZ	VM1921A0	PIASTRINA SX CHIUSURA VETRO INT	1	PZ	VM2062A0	TAPPO COLONNINA LM600 SUP DX	1	PZ	VM2063A0	TAPPO COLONNINA LM600 SUP SX	1	PZ	VM2064A0	TAPPO COLONNINA LM600 INF DX	1	PZ	VM2065A0	TAPPO COLONNINA LM600 INF SX	1	PZ	VT1061A2	VETRO ESTERNO SER. GIALLO 598X424X5	1	PZ	VT1061A2	VETRO ESTERNO SER. GIALLO 598X424X5	1	PZ	KVT1057A	KIT VETRO ESTERNO NERO LMISS STEFANIA	<table border="1"> <thead> <tr> <th>Codice</th> <th>Descrizione</th> <th>Qtà</th> <th>UM</th> </tr> </thead> <tbody> <tr> <td>IP1385A1</td> <td>IMB POL ANGOLARE 110X80X2000 D30</td> <td>0.810</td> <td>M</td> </tr> </tbody> </table>	Codice	Descrizione	Qtà	UM	IP1385A1	IMB POL ANGOLARE 110X80X2000 D30	0.810	M
			Codice	Descrizione	Qtà	UM																																																																										
IP1385A1	IMB POL ANGOLARE 110X80X2000 D30	1.280	M																																																																													
RC1200A0	MOLLA A COMPRESSIO NE DE4 DF0.5 H24	2	PZ																																																																													
SL1050A1	NASTRO BIADESIVO 3M TRANSFER VH	0.820	M																																																																													
TB2301A0	COLONNINA DX XVC105E 40X40X1	2	PZ																																																																													
VM1025A0	TAPPO NYLON PA66 V2 GRIGIO Ø16	2	PZ																																																																													
VM1059A1	FILM TERMORETRA IBILE H800	1.300	M																																																																													
VM1695A0	PERNO POSIZIONE MANIGLIA	2	PZ																																																																													
VM1920A0	PIASTRINA DX CHIUSURA VETRO INT	1	PZ																																																																													
VM1921A0	PIASTRINA SX CHIUSURA VETRO INT	1	PZ																																																																													
VM2062A0	TAPPO COLONNINA LM600 SUP DX	1	PZ																																																																													
VM2063A0	TAPPO COLONNINA LM600 SUP SX	1	PZ																																																																													
VM2064A0	TAPPO COLONNINA LM600 INF DX	1	PZ																																																																													
VM2065A0	TAPPO COLONNINA LM600 INF SX	1	PZ																																																																													
VT1061A2	VETRO ESTERNO SER. GIALLO 598X424X5	1	PZ																																																																													
VT1061A2	VETRO ESTERNO SER. GIALLO 598X424X5	1	PZ																																																																													
Codice	Descrizione	Qtà	UM																																																																													
IP1385A1	IMB POL ANGOLARE 110X80X2000 D30	0.810	M																																																																													

COMPONENTE			RICAMBIO																																																																						
Codice	Descrizione	Immagine	Codice	Descrizione	Lista componenti																																																																				
VM1920A	PIASTRINA DX CHIUSURA VETRO INT		KVT1057A	KIT VETRO ESTERNO NERO LMISS STEFANIA	<table border="1"> <thead> <tr> <th>Codice</th> <th>Descrizione</th> <th>Qtà</th> <th>UM</th> </tr> </thead> <tbody> <tr> <td>IP1508A1</td> <td>POLISTIROLO PROFILO AD U 2000X60X60</td> <td>0.960</td> <td>M</td> </tr> <tr> <td>RC1200A0</td> <td>MOLLA A COMPRESSIO NE DE4 DF0.5 H24</td> <td>2</td> <td>PZ</td> </tr> <tr> <td>SL1050A1</td> <td>NASTRO BIADESIVO 3M TRANSFER VH</td> <td>0.660</td> <td>M</td> </tr> <tr> <td>TB2306A0</td> <td>COLONNINA DX LM STE-ELE 40X40X1</td> <td>1</td> <td>PZ</td> </tr> <tr> <td>TB3080A0</td> <td>COLONNINA SX LM STE-EL</td> <td>1</td> <td>PZ</td> </tr> <tr> <td>VM1025A0</td> <td>TAPPO NYLON PA66 V2 GRIGIO Ø16</td> <td>2</td> <td>PZ</td> </tr> <tr> <td>VM1059A1</td> <td>FILM TERMORETRA IBILE H800</td> <td>1</td> <td>M</td> </tr> <tr> <td>VM1695A0</td> <td>PERNO POSIZIONE MANIGLIA</td> <td>2</td> <td>PZ</td> </tr> <tr> <td>VM1920A0</td> <td>PIASTRINA DX CHIUSURA VETRO INT</td> <td>1</td> <td>PZ</td> </tr> <tr> <td>VM1921A0</td> <td>PIASTRINA SX CHIUSURA VETRO INT</td> <td>1</td> <td>PZ</td> </tr> <tr> <td>VM2062A0</td> <td>TAPPO COLONNINA LM600 SUP DX</td> <td>1</td> <td>PZ</td> </tr> <tr> <td>VM2063A0</td> <td>TAPPO COLONNINA LM600 SUP SX</td> <td>1</td> <td>PZ</td> </tr> <tr> <td>VM2064A0</td> <td>TAPPO COLONNINA LM600 INF DX</td> <td>1</td> <td>PZ</td> </tr> <tr> <td>VM2065A0</td> <td>TAPPO COLONNINA LM600 INF SX</td> <td>1</td> <td>PZ</td> </tr> <tr> <td>VT1057A0</td> <td>VETRO ESTERNO SER. GRIGIO 598X344X5</td> <td>1</td> <td>PZ</td> </tr> <tr> <td>VT1057A0</td> <td>VETRO ESTERNO SER. GRIGIO 598X344X5</td> <td>1</td> <td>PZ</td> </tr> </tbody> </table>	Codice	Descrizione	Qtà	UM	IP1508A1	POLISTIROLO PROFILO AD U 2000X60X60	0.960	M	RC1200A0	MOLLA A COMPRESSIO NE DE4 DF0.5 H24	2	PZ	SL1050A1	NASTRO BIADESIVO 3M TRANSFER VH	0.660	M	TB2306A0	COLONNINA DX LM STE-ELE 40X40X1	1	PZ	TB3080A0	COLONNINA SX LM STE-EL	1	PZ	VM1025A0	TAPPO NYLON PA66 V2 GRIGIO Ø16	2	PZ	VM1059A1	FILM TERMORETRA IBILE H800	1	M	VM1695A0	PERNO POSIZIONE MANIGLIA	2	PZ	VM1920A0	PIASTRINA DX CHIUSURA VETRO INT	1	PZ	VM1921A0	PIASTRINA SX CHIUSURA VETRO INT	1	PZ	VM2062A0	TAPPO COLONNINA LM600 SUP DX	1	PZ	VM2063A0	TAPPO COLONNINA LM600 SUP SX	1	PZ	VM2064A0	TAPPO COLONNINA LM600 INF DX	1	PZ	VM2065A0	TAPPO COLONNINA LM600 INF SX	1	PZ	VT1057A0	VETRO ESTERNO SER. GRIGIO 598X344X5	1	PZ	VT1057A0	VETRO ESTERNO SER. GRIGIO 598X344X5	1	PZ
Codice	Descrizione	Qtà	UM																																																																						
IP1508A1	POLISTIROLO PROFILO AD U 2000X60X60	0.960	M																																																																						
RC1200A0	MOLLA A COMPRESSIO NE DE4 DF0.5 H24	2	PZ																																																																						
SL1050A1	NASTRO BIADESIVO 3M TRANSFER VH	0.660	M																																																																						
TB2306A0	COLONNINA DX LM STE-ELE 40X40X1	1	PZ																																																																						
TB3080A0	COLONNINA SX LM STE-EL	1	PZ																																																																						
VM1025A0	TAPPO NYLON PA66 V2 GRIGIO Ø16	2	PZ																																																																						
VM1059A1	FILM TERMORETRA IBILE H800	1	M																																																																						
VM1695A0	PERNO POSIZIONE MANIGLIA	2	PZ																																																																						
VM1920A0	PIASTRINA DX CHIUSURA VETRO INT	1	PZ																																																																						
VM1921A0	PIASTRINA SX CHIUSURA VETRO INT	1	PZ																																																																						
VM2062A0	TAPPO COLONNINA LM600 SUP DX	1	PZ																																																																						
VM2063A0	TAPPO COLONNINA LM600 SUP SX	1	PZ																																																																						
VM2064A0	TAPPO COLONNINA LM600 INF DX	1	PZ																																																																						
VM2065A0	TAPPO COLONNINA LM600 INF SX	1	PZ																																																																						
VT1057A0	VETRO ESTERNO SER. GRIGIO 598X344X5	1	PZ																																																																						
VT1057A0	VETRO ESTERNO SER. GRIGIO 598X344X5	1	PZ																																																																						

COMPONENTE			RICAMBIO																																																																						
Codice	Descrizione	Immagine	Codice	Descrizione	Lista componenti																																																																				
VM1920A	PIASTRINA DX CHIUSURA VETRO INT		KVT1056A	KIT VETRO ESTERNO GIALLO LMISS STEFANIA	<table border="1"> <thead> <tr> <th>Codice</th> <th>Descrizione</th> <th>Qtà</th> <th>UM</th> </tr> </thead> <tbody> <tr> <td>IP1385A1</td> <td>IMB POL ANGOLARE 110X80X2000 D30</td> <td>0.980</td> <td>M</td> </tr> <tr> <td>IP1508A1</td> <td>POLISTIROLO PROFILO AD U 2000X60X60</td> <td>0.960</td> <td>M</td> </tr> <tr> <td>RC1200A0</td> <td>MOLLA A COMPRESSIO NE DE4 DF0.5 H24</td> <td>2</td> <td>PZ</td> </tr> <tr> <td>SL1050A1</td> <td>NASTRO BIADESIVO 3M TRANSFER VH</td> <td>0.660</td> <td>M</td> </tr> <tr> <td>TB2306A0</td> <td>COLONNINA DX LM STE-ELE 40X40X1</td> <td>2</td> <td>PZ</td> </tr> <tr> <td>VM1025A0</td> <td>TAPPO NYLON PA66 V2 GRIGIO Ø16</td> <td>2</td> <td>PZ</td> </tr> <tr> <td>VM1059A1</td> <td>FILM TERMORETRA IBILE H800</td> <td>1.300</td> <td>M</td> </tr> <tr> <td>VM1695A0</td> <td>PERNO POSIZIONE MANIGLIA</td> <td>2</td> <td>PZ</td> </tr> <tr> <td>VM1920A0</td> <td>PIASTRINA DX CHIUSURA VETRO INT</td> <td>1</td> <td>PZ</td> </tr> <tr> <td>VM1921A0</td> <td>PIASTRINA SX CHIUSURA VETRO INT</td> <td>1</td> <td>PZ</td> </tr> <tr> <td>VM2062A0</td> <td>TAPPO COLONNINA LM600 SUP DX</td> <td>1</td> <td>PZ</td> </tr> <tr> <td>VM2063A0</td> <td>TAPPO COLONNINA LM600 SUP SX</td> <td>1</td> <td>PZ</td> </tr> <tr> <td>VM2064A0</td> <td>TAPPO COLONNINA LM600 INF DX</td> <td>1</td> <td>PZ</td> </tr> <tr> <td>VM2065A0</td> <td>TAPPO COLONNINA LM600 INF SX</td> <td>1</td> <td>PZ</td> </tr> <tr> <td>VT1056A2</td> <td>VETRO ESTERNO SER. GIALLO 598X344X5</td> <td>1</td> <td>PZ</td> </tr> <tr> <td>VT1056A2</td> <td>VETRO ESTERNO SER. GIALLO 598X344X5</td> <td>1</td> <td>PZ</td> </tr> </tbody> </table>	Codice	Descrizione	Qtà	UM	IP1385A1	IMB POL ANGOLARE 110X80X2000 D30	0.980	M	IP1508A1	POLISTIROLO PROFILO AD U 2000X60X60	0.960	M	RC1200A0	MOLLA A COMPRESSIO NE DE4 DF0.5 H24	2	PZ	SL1050A1	NASTRO BIADESIVO 3M TRANSFER VH	0.660	M	TB2306A0	COLONNINA DX LM STE-ELE 40X40X1	2	PZ	VM1025A0	TAPPO NYLON PA66 V2 GRIGIO Ø16	2	PZ	VM1059A1	FILM TERMORETRA IBILE H800	1.300	M	VM1695A0	PERNO POSIZIONE MANIGLIA	2	PZ	VM1920A0	PIASTRINA DX CHIUSURA VETRO INT	1	PZ	VM1921A0	PIASTRINA SX CHIUSURA VETRO INT	1	PZ	VM2062A0	TAPPO COLONNINA LM600 SUP DX	1	PZ	VM2063A0	TAPPO COLONNINA LM600 SUP SX	1	PZ	VM2064A0	TAPPO COLONNINA LM600 INF DX	1	PZ	VM2065A0	TAPPO COLONNINA LM600 INF SX	1	PZ	VT1056A2	VETRO ESTERNO SER. GIALLO 598X344X5	1	PZ	VT1056A2	VETRO ESTERNO SER. GIALLO 598X344X5	1	PZ
Codice	Descrizione	Qtà	UM																																																																						
IP1385A1	IMB POL ANGOLARE 110X80X2000 D30	0.980	M																																																																						
IP1508A1	POLISTIROLO PROFILO AD U 2000X60X60	0.960	M																																																																						
RC1200A0	MOLLA A COMPRESSIO NE DE4 DF0.5 H24	2	PZ																																																																						
SL1050A1	NASTRO BIADESIVO 3M TRANSFER VH	0.660	M																																																																						
TB2306A0	COLONNINA DX LM STE-ELE 40X40X1	2	PZ																																																																						
VM1025A0	TAPPO NYLON PA66 V2 GRIGIO Ø16	2	PZ																																																																						
VM1059A1	FILM TERMORETRA IBILE H800	1.300	M																																																																						
VM1695A0	PERNO POSIZIONE MANIGLIA	2	PZ																																																																						
VM1920A0	PIASTRINA DX CHIUSURA VETRO INT	1	PZ																																																																						
VM1921A0	PIASTRINA SX CHIUSURA VETRO INT	1	PZ																																																																						
VM2062A0	TAPPO COLONNINA LM600 SUP DX	1	PZ																																																																						
VM2063A0	TAPPO COLONNINA LM600 SUP SX	1	PZ																																																																						
VM2064A0	TAPPO COLONNINA LM600 INF DX	1	PZ																																																																						
VM2065A0	TAPPO COLONNINA LM600 INF SX	1	PZ																																																																						
VT1056A2	VETRO ESTERNO SER. GIALLO 598X344X5	1	PZ																																																																						
VT1056A2	VETRO ESTERNO SER. GIALLO 598X344X5	1	PZ																																																																						

COMPONENTE			RICAMBIO																																																										
Codice	Descrizione	Immagine	Codice	Descrizione	Lista componenti																																																								
VM1920A	PIASTRINA DX CHIUSURA VETRO INT		KVT1052A	KIT VETRO ESTERNO NERO LINEMISS CRISTINA	<table border="1"> <thead> <tr> <th>Codice</th> <th>Descrizione</th> <th>Qtà</th> <th>UM</th> </tr> </thead> <tbody> <tr> <td>RC1200A0</td> <td>MOLLA A COMPRESSIO NE DE4 DF0.5 H24</td> <td>2</td> <td>PZ</td> </tr> <tr> <td>SL1050A1</td> <td>NASTRO BIADESIVO 3M TRANSFER VH</td> <td>0.660</td> <td>M</td> </tr> <tr> <td>TB2306A0</td> <td>COLONNINA DX LM STE-ELE 40X40X1</td> <td>2</td> <td>PZ</td> </tr> <tr> <td>VM1025A0</td> <td>TAPPO NYLON PA66 V2 GRIGIO Ø16</td> <td>2</td> <td>PZ</td> </tr> <tr> <td>VM1695A0</td> <td>PERNO POSIZIONE MANIGLIA</td> <td>2</td> <td>PZ</td> </tr> <tr> <td>VM1920A0</td> <td>PIASTRINA DX CHIUSURA VETRO INT</td> <td>1</td> <td>PZ</td> </tr> <tr> <td>VM1921A0</td> <td>PIASTRINA SX CHIUSURA VETRO INT</td> <td>1</td> <td>PZ</td> </tr> <tr> <td>VM2062A0</td> <td>TAPPO COLONNINA LM600 SUP DX</td> <td>1</td> <td>PZ</td> </tr> <tr> <td>VM2063A0</td> <td>TAPPO COLONNINA LM600 SUP SX</td> <td>1</td> <td>PZ</td> </tr> <tr> <td>VM2064A0</td> <td>TAPPO COLONNINA LM600 INF DX</td> <td>1</td> <td>PZ</td> </tr> <tr> <td>VM2065A0</td> <td>TAPPO COLONNINA LM600 INF SX</td> <td>1</td> <td>PZ</td> </tr> <tr> <td>VT1052A0</td> <td>VETRO ESTERNO SER. GRIGIO 478X344X5</td> <td>1</td> <td>PZ</td> </tr> <tr> <td>VT1052A0</td> <td>VETRO ESTERNO SER. GRIGIO 478X344X5</td> <td>1</td> <td>PZ</td> </tr> </tbody> </table>	Codice	Descrizione	Qtà	UM	RC1200A0	MOLLA A COMPRESSIO NE DE4 DF0.5 H24	2	PZ	SL1050A1	NASTRO BIADESIVO 3M TRANSFER VH	0.660	M	TB2306A0	COLONNINA DX LM STE-ELE 40X40X1	2	PZ	VM1025A0	TAPPO NYLON PA66 V2 GRIGIO Ø16	2	PZ	VM1695A0	PERNO POSIZIONE MANIGLIA	2	PZ	VM1920A0	PIASTRINA DX CHIUSURA VETRO INT	1	PZ	VM1921A0	PIASTRINA SX CHIUSURA VETRO INT	1	PZ	VM2062A0	TAPPO COLONNINA LM600 SUP DX	1	PZ	VM2063A0	TAPPO COLONNINA LM600 SUP SX	1	PZ	VM2064A0	TAPPO COLONNINA LM600 INF DX	1	PZ	VM2065A0	TAPPO COLONNINA LM600 INF SX	1	PZ	VT1052A0	VETRO ESTERNO SER. GRIGIO 478X344X5	1	PZ	VT1052A0	VETRO ESTERNO SER. GRIGIO 478X344X5	1	PZ
Codice	Descrizione	Qtà	UM																																																										
RC1200A0	MOLLA A COMPRESSIO NE DE4 DF0.5 H24	2	PZ																																																										
SL1050A1	NASTRO BIADESIVO 3M TRANSFER VH	0.660	M																																																										
TB2306A0	COLONNINA DX LM STE-ELE 40X40X1	2	PZ																																																										
VM1025A0	TAPPO NYLON PA66 V2 GRIGIO Ø16	2	PZ																																																										
VM1695A0	PERNO POSIZIONE MANIGLIA	2	PZ																																																										
VM1920A0	PIASTRINA DX CHIUSURA VETRO INT	1	PZ																																																										
VM1921A0	PIASTRINA SX CHIUSURA VETRO INT	1	PZ																																																										
VM2062A0	TAPPO COLONNINA LM600 SUP DX	1	PZ																																																										
VM2063A0	TAPPO COLONNINA LM600 SUP SX	1	PZ																																																										
VM2064A0	TAPPO COLONNINA LM600 INF DX	1	PZ																																																										
VM2065A0	TAPPO COLONNINA LM600 INF SX	1	PZ																																																										
VT1052A0	VETRO ESTERNO SER. GRIGIO 478X344X5	1	PZ																																																										
VT1052A0	VETRO ESTERNO SER. GRIGIO 478X344X5	1	PZ																																																										
			KVT1051A	KIT VETRO ESTERNO GIALLO L.MISS CRISTINA	<table border="1"> <thead> <tr> <th>Codice</th> <th>Descrizione</th> <th>Qtà</th> <th>UM</th> </tr> </thead> <tbody> <tr> <td>IP1385A1</td> <td>IMB POL ANGOLARE 110X80X2000 D30</td> <td>1.040</td> <td>M</td> </tr> <tr> <td>RC1200A0</td> <td>MOLLA A COMPRESSIO NE DE4 DF0.5 H24</td> <td>2</td> <td>PZ</td> </tr> </tbody> </table>	Codice	Descrizione	Qtà	UM	IP1385A1	IMB POL ANGOLARE 110X80X2000 D30	1.040	M	RC1200A0	MOLLA A COMPRESSIO NE DE4 DF0.5 H24	2	PZ																																												
Codice	Descrizione	Qtà	UM																																																										
IP1385A1	IMB POL ANGOLARE 110X80X2000 D30	1.040	M																																																										
RC1200A0	MOLLA A COMPRESSIO NE DE4 DF0.5 H24	2	PZ																																																										

COMPONENTE			RICAMBIO																																																										
Codice	Descrizione	Immagine	Codice	Descrizione	Lista componenti																																																								
VM1920A	PIASTRINA DX CHIUSURA VETRO INT		KVT1051A	KIT VETRO ESTERNO GIALLO L.MISS CRISTINA	<table border="1"> <thead> <tr> <th>Codice</th> <th>Descrizione</th> <th>Qtà</th> <th>UM</th> </tr> </thead> <tbody> <tr> <td>SL1050A1</td> <td>NASTRO BIADESIVO 3M TRANSFER VH</td> <td>0.660</td> <td>M</td> </tr> <tr> <td>TB2306A0</td> <td>COLONNINA DX LM STE-ELE 40X40X1</td> <td>2</td> <td>PZ</td> </tr> <tr> <td>VM1025A0</td> <td>TAPPO NYLON PA66 V2 GRIGIO Ø16</td> <td>2</td> <td>PZ</td> </tr> <tr> <td>VM1059A1</td> <td>FILM TERMORETRA IBILE H800</td> <td>1.500</td> <td>M</td> </tr> <tr> <td>VM1695A0</td> <td>PERNO POSIZIONE MANIGLIA</td> <td>2</td> <td>PZ</td> </tr> <tr> <td>VM1920A0</td> <td>PIASTRINA DX CHIUSURA VETRO INT</td> <td>1</td> <td>PZ</td> </tr> <tr> <td>VM1921A0</td> <td>PIASTRINA SX CHIUSURA VETRO INT</td> <td>1</td> <td>PZ</td> </tr> <tr> <td>VM2062A0</td> <td>TAPPO COLONNINA LM600 SUP DX</td> <td>1</td> <td>PZ</td> </tr> <tr> <td>VM2063A0</td> <td>TAPPO COLONNINA LM600 SUP SX</td> <td>1</td> <td>PZ</td> </tr> <tr> <td>VM2064A0</td> <td>TAPPO COLONNINA LM600 INF DX</td> <td>1</td> <td>PZ</td> </tr> <tr> <td>VM2065A0</td> <td>TAPPO COLONNINA LM600 INF SX</td> <td>1</td> <td>PZ</td> </tr> <tr> <td>VT1051A2</td> <td>VETRO ESTERNO SER. GIALLO 478X344X5</td> <td>1</td> <td>PZ</td> </tr> <tr> <td>VT1051A2</td> <td>VETRO ESTERNO SER. GIALLO 478X344X5</td> <td>1</td> <td>PZ</td> </tr> </tbody> </table>	Codice	Descrizione	Qtà	UM	SL1050A1	NASTRO BIADESIVO 3M TRANSFER VH	0.660	M	TB2306A0	COLONNINA DX LM STE-ELE 40X40X1	2	PZ	VM1025A0	TAPPO NYLON PA66 V2 GRIGIO Ø16	2	PZ	VM1059A1	FILM TERMORETRA IBILE H800	1.500	M	VM1695A0	PERNO POSIZIONE MANIGLIA	2	PZ	VM1920A0	PIASTRINA DX CHIUSURA VETRO INT	1	PZ	VM1921A0	PIASTRINA SX CHIUSURA VETRO INT	1	PZ	VM2062A0	TAPPO COLONNINA LM600 SUP DX	1	PZ	VM2063A0	TAPPO COLONNINA LM600 SUP SX	1	PZ	VM2064A0	TAPPO COLONNINA LM600 INF DX	1	PZ	VM2065A0	TAPPO COLONNINA LM600 INF SX	1	PZ	VT1051A2	VETRO ESTERNO SER. GIALLO 478X344X5	1	PZ	VT1051A2	VETRO ESTERNO SER. GIALLO 478X344X5	1	PZ
Codice	Descrizione	Qtà	UM																																																										
SL1050A1	NASTRO BIADESIVO 3M TRANSFER VH	0.660	M																																																										
TB2306A0	COLONNINA DX LM STE-ELE 40X40X1	2	PZ																																																										
VM1025A0	TAPPO NYLON PA66 V2 GRIGIO Ø16	2	PZ																																																										
VM1059A1	FILM TERMORETRA IBILE H800	1.500	M																																																										
VM1695A0	PERNO POSIZIONE MANIGLIA	2	PZ																																																										
VM1920A0	PIASTRINA DX CHIUSURA VETRO INT	1	PZ																																																										
VM1921A0	PIASTRINA SX CHIUSURA VETRO INT	1	PZ																																																										
VM2062A0	TAPPO COLONNINA LM600 SUP DX	1	PZ																																																										
VM2063A0	TAPPO COLONNINA LM600 SUP SX	1	PZ																																																										
VM2064A0	TAPPO COLONNINA LM600 INF DX	1	PZ																																																										
VM2065A0	TAPPO COLONNINA LM600 INF SX	1	PZ																																																										
VT1051A2	VETRO ESTERNO SER. GIALLO 478X344X5	1	PZ																																																										
VT1051A2	VETRO ESTERNO SER. GIALLO 478X344X5	1	PZ																																																										
VM1917A	TAPPO COLONNINA SUP SX		KVM1917A	KIT TAPPO COLONNINA SUPERIORE SX LM800	<table border="1"> <thead> <tr> <th>Codice</th> <th>Descrizione</th> <th>Qtà</th> <th>UM</th> </tr> </thead> <tbody> <tr> <td>VM1917A0</td> <td>TAPPO COLONNINA SUP SX</td> <td>1</td> <td>PZ</td> </tr> </tbody> </table>	Codice	Descrizione	Qtà	UM	VM1917A0	TAPPO COLONNINA SUP SX	1	PZ																																																
Codice	Descrizione	Qtà	UM																																																										
VM1917A0	TAPPO COLONNINA SUP SX	1	PZ																																																										

COMPONENTE			RICAMBIO																		
Codice	Descrizione	Immagine	Codice	Descrizione	Lista componenti																
LP1036A	BARRA LED E200 L200 LM COMPLETA		KLP1036A	KIT BARRA LED L200 LMISS	<table border="1"> <thead> <tr> <th>Codice</th> <th>Descrizione</th> <th>Qtà</th> <th>UM</th> </tr> </thead> <tbody> <tr> <td>IP1385A1</td> <td>IMB POL ANGOLARE 110X80X2000 D30</td> <td>0.700</td> <td>M</td> </tr> <tr> <td>LP1036A2</td> <td>BARRA LED E200 L200 LM-LUX COMPLETA</td> <td>1</td> <td>PZ</td> </tr> <tr> <td>VM1059A1</td> <td>FILM TERMORETRA IBILE H800</td> <td>0.700</td> <td>M</td> </tr> </tbody> </table>	Codice	Descrizione	Qtà	UM	IP1385A1	IMB POL ANGOLARE 110X80X2000 D30	0.700	M	LP1036A2	BARRA LED E200 L200 LM-LUX COMPLETA	1	PZ	VM1059A1	FILM TERMORETRA IBILE H800	0.700	M
Codice	Descrizione	Qtà	UM																		
IP1385A1	IMB POL ANGOLARE 110X80X2000 D30	0.700	M																		
LP1036A2	BARRA LED E200 L200 LM-LUX COMPLETA	1	PZ																		
VM1059A1	FILM TERMORETRA IBILE H800	0.700	M																		

ASM2012D/0.D00 - Camera di cottura



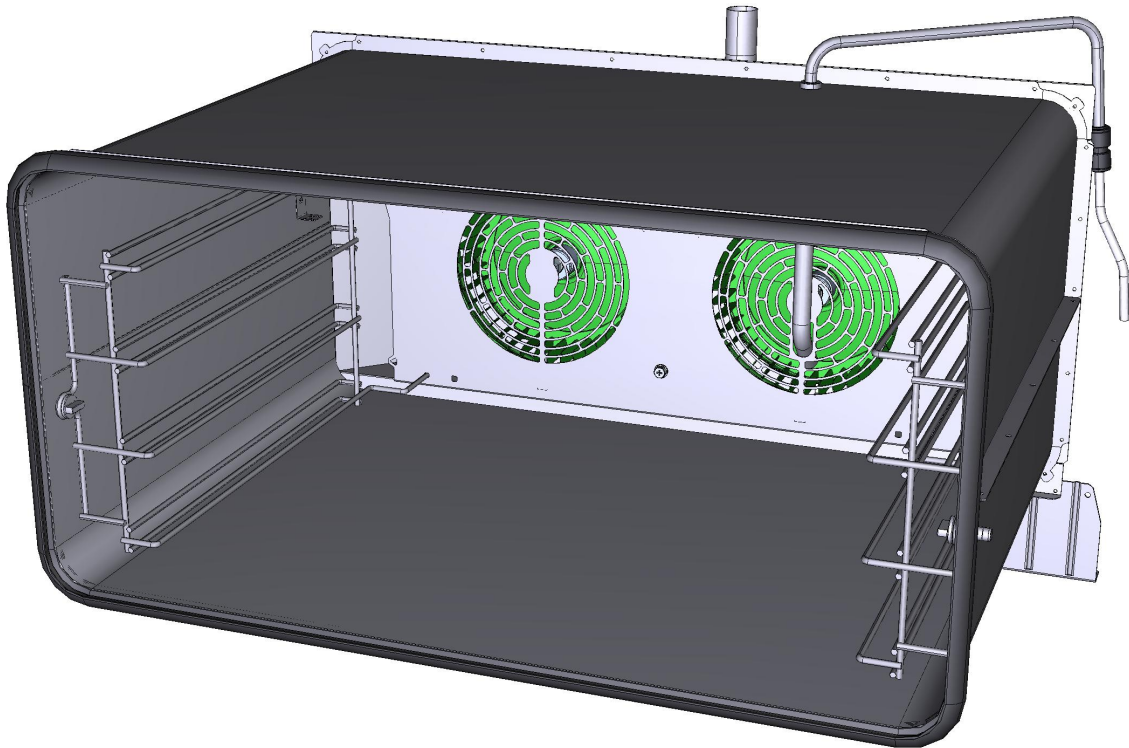

FRONTE



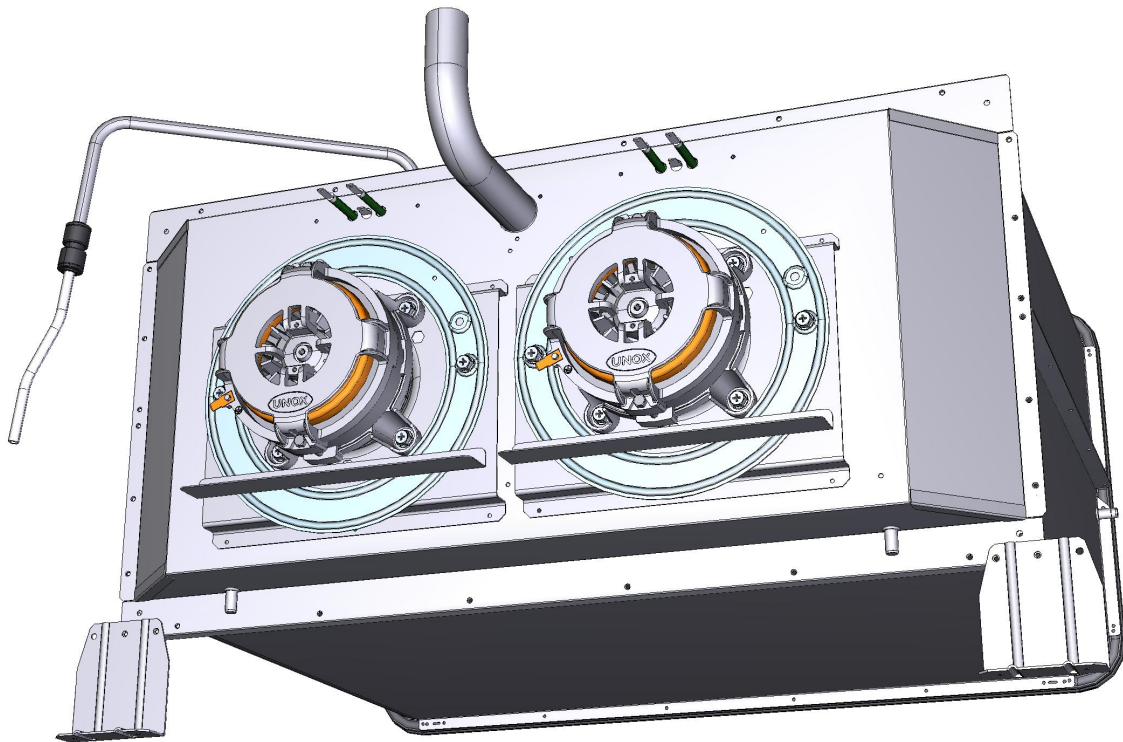





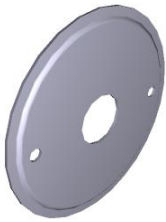

ASM2012D/0.D00 - Camera di cottura

RETRO





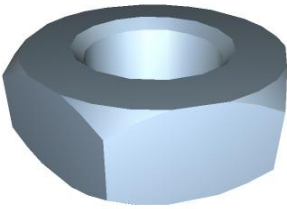

COMPONENTE			RICAMBIO																										
Codice	Descrizione	Immagine	Codice	Descrizione	Lista componenti																								
0G1524B	DIVISORIO CARTER ARIA LM XFT200		0G1524B0	DIVISORIO CARTER ARIA LM XFT200																									
0G1537A	CARTER ARIA LM ROSSELLA		0G1537A1	CARTER ARIA LM ROSSELLA																									
0H3586A	LAMIERA PROTEZIONE MOTORE ZINCATO		0H3586A0	LAMIERA PROTEZIONE MOTORE ZINCATO																									
VN1025A	VENTOLA D=196 H=61 38 PALE INOX DADO M8		KVN1025A	KIT VENTOLA D196 H61	<table border="1"> <thead> <tr> <th>Codice</th> <th>Descrizione</th> <th>Qta</th> <th>UM</th> </tr> </thead> <tbody> <tr> <td>VI1045A0</td> <td>RONDELLA 16X8,4 SP.1,6 INOX UNI6592</td> <td>1</td> <td>PZ</td> </tr> <tr> <td>VI1256A0</td> <td>DADO M8 DIN 980M AUTOBLOCCA NTE INOX</td> <td>1</td> <td>PZ</td> </tr> <tr> <td>VM2196A0</td> <td>BOCCOLA FISSAGGIO DADO MOTOR</td> <td>1</td> <td>PZ</td> </tr> <tr> <td>VN1025A2</td> <td>VENTOLA D=196 H=61 38 PALE INOX DADO M8</td> <td>1</td> <td>PZ</td> </tr> <tr> <td>VN1025A2</td> <td>VENTOLA D=196 H=61 38 PALE INOX DADO M8</td> <td>1</td> <td>PZ</td> </tr> </tbody> </table>	Codice	Descrizione	Qta	UM	VI1045A0	RONDELLA 16X8,4 SP.1,6 INOX UNI6592	1	PZ	VI1256A0	DADO M8 DIN 980M AUTOBLOCCA NTE INOX	1	PZ	VM2196A0	BOCCOLA FISSAGGIO DADO MOTOR	1	PZ	VN1025A2	VENTOLA D=196 H=61 38 PALE INOX DADO M8	1	PZ	VN1025A2	VENTOLA D=196 H=61 38 PALE INOX DADO M8	1	PZ
Codice	Descrizione	Qta	UM																										
VI1045A0	RONDELLA 16X8,4 SP.1,6 INOX UNI6592	1	PZ																										
VI1256A0	DADO M8 DIN 980M AUTOBLOCCA NTE INOX	1	PZ																										
VM2196A0	BOCCOLA FISSAGGIO DADO MOTOR	1	PZ																										
VN1025A2	VENTOLA D=196 H=61 38 PALE INOX DADO M8	1	PZ																										
VN1025A2	VENTOLA D=196 H=61 38 PALE INOX DADO M8	1	PZ																										

COMPONENTE			RICAMBIO																																		
Codice	Descrizione	Immagine	Codice	Descrizione	Lista componenti																																
0H3020A	DISCO TENUTA ALBERO MOTORE		0H3020A1	DISCO TENUTA ALBERO MOTORE																																	
0H1209A	ALETTA PARACALORE ARIA MOTORE		0H1209A0	ALETTA PARACALORE ARIA MOTORE																																	
GN1547A	GUARNIZIONE ALBERO MOTORE D11.6																																				
VN1130A	MOTORE FORNO 330W 230V 50/60HZ ALBERO M8		KVN1130A	KIT MOTORE 330W 230V 50/60HZ	<table border="1"> <thead> <tr> <th>Codice</th> <th>Descrizione</th> <th>Qtà</th> <th>UM</th> </tr> </thead> <tbody> <tr> <td>0H4305A1</td> <td>DISCO TENUTA ALBERO MOTORE INOX STP</td> <td>1</td> <td>PZ</td> </tr> <tr> <td>GN1140A2</td> <td>GUARNIZIONE PORTAMOTO RE STAMPAT</td> <td>1</td> <td>PZ</td> </tr> <tr> <td>VI1045A0</td> <td>RONDELLA 16X8,4 SP.1,6 INOX UNI6592</td> <td>1</td> <td>PZ</td> </tr> <tr> <td>VI1256A0</td> <td>DADO M8 DIN 980M AUTOBLOCCA NTE INOX</td> <td>1</td> <td>PZ</td> </tr> <tr> <td>VM1794A0</td> <td>FASCETTA 250X4.8 PA66 NERA</td> <td>4</td> <td>PZ</td> </tr> <tr> <td>VM2103A0</td> <td>PIASTRINA FERMAFASCE TTA</td> <td>4</td> <td>PZ</td> </tr> <tr> <td>VM2196A0</td> <td>BOCCOLA FISSAGGIO DADO MOTOR</td> <td>1</td> <td>PZ</td> </tr> </tbody> </table>	Codice	Descrizione	Qtà	UM	0H4305A1	DISCO TENUTA ALBERO MOTORE INOX STP	1	PZ	GN1140A2	GUARNIZIONE PORTAMOTO RE STAMPAT	1	PZ	VI1045A0	RONDELLA 16X8,4 SP.1,6 INOX UNI6592	1	PZ	VI1256A0	DADO M8 DIN 980M AUTOBLOCCA NTE INOX	1	PZ	VM1794A0	FASCETTA 250X4.8 PA66 NERA	4	PZ	VM2103A0	PIASTRINA FERMAFASCE TTA	4	PZ	VM2196A0	BOCCOLA FISSAGGIO DADO MOTOR	1	PZ
Codice	Descrizione	Qtà	UM																																		
0H4305A1	DISCO TENUTA ALBERO MOTORE INOX STP	1	PZ																																		
GN1140A2	GUARNIZIONE PORTAMOTO RE STAMPAT	1	PZ																																		
VI1045A0	RONDELLA 16X8,4 SP.1,6 INOX UNI6592	1	PZ																																		
VI1256A0	DADO M8 DIN 980M AUTOBLOCCA NTE INOX	1	PZ																																		
VM1794A0	FASCETTA 250X4.8 PA66 NERA	4	PZ																																		
VM2103A0	PIASTRINA FERMAFASCE TTA	4	PZ																																		
VM2196A0	BOCCOLA FISSAGGIO DADO MOTOR	1	PZ																																		

COMPONENTE			RICAMBIO																														
Codice	Descrizione	Immagine	Codice	Descrizione	Lista componenti																												
VN1130A	MOTORE FORNO 330W 230V 50/60HZ ALBERO M8		KVN1130A	KIT MOTORE 330W 230V 50/60HZ	<table border="1"> <thead> <tr> <th>Codice</th> <th>Descrizione</th> <th>Qtà</th> <th>UM</th> </tr> </thead> <tbody> <tr> <td>VN1130A1</td> <td>MOTORE FORNO 330W 230V 50/60HZ ALBERO M8</td> <td>1</td> <td>PZ</td> </tr> <tr> <td>VN1130A1</td> <td>MOTORE FORNO 330W 230V 50/60HZ ALBERO M8</td> <td>1</td> <td>PZ</td> </tr> </tbody> </table>	Codice	Descrizione	Qtà	UM	VN1130A1	MOTORE FORNO 330W 230V 50/60HZ ALBERO M8	1	PZ	VN1130A1	MOTORE FORNO 330W 230V 50/60HZ ALBERO M8	1	PZ																
Codice	Descrizione	Qtà	UM																														
VN1130A1	MOTORE FORNO 330W 230V 50/60HZ ALBERO M8	1	PZ																														
VN1130A1	MOTORE FORNO 330W 230V 50/60HZ ALBERO M8	1	PZ																														
RS1090A	RESISTENZA CIRCOLARE D=230 3 SPIRE		KRS1090A	KIT RESISTENZA 2.9KW	<table border="1"> <thead> <tr> <th>Codice</th> <th>Descrizione</th> <th>Qtà</th> <th>UM</th> </tr> </thead> <tbody> <tr> <td>GN1327A0</td> <td>GUARNIZIONE RESISTENZA 100X22</td> <td>1</td> <td>PZ</td> </tr> <tr> <td>RS1090A1</td> <td>RESISTENZA CIRCOLARE D=230 3 SPIRE</td> <td>1</td> <td>PZ</td> </tr> <tr> <td>SL1045A0</td> <td>SILICONE ANTRACITE S53 80 ML</td> <td>1</td> <td>PZ</td> </tr> <tr> <td>VI1220A1</td> <td>VITE AUTOFILETTA NTE 4.2X11 TCS+ MARUTE</td> <td>5</td> <td>PZ</td> </tr> <tr> <td>VM1794A0</td> <td>FASCETTA 250X4.8 PA66 NERA</td> <td>2</td> <td>PZ</td> </tr> <tr> <td>VM2103A0</td> <td>PIASTRINA FERMAFASCE TTA</td> <td>2</td> <td>PZ</td> </tr> </tbody> </table>	Codice	Descrizione	Qtà	UM	GN1327A0	GUARNIZIONE RESISTENZA 100X22	1	PZ	RS1090A1	RESISTENZA CIRCOLARE D=230 3 SPIRE	1	PZ	SL1045A0	SILICONE ANTRACITE S53 80 ML	1	PZ	VI1220A1	VITE AUTOFILETTA NTE 4.2X11 TCS+ MARUTE	5	PZ	VM1794A0	FASCETTA 250X4.8 PA66 NERA	2	PZ	VM2103A0	PIASTRINA FERMAFASCE TTA	2	PZ
Codice	Descrizione	Qtà	UM																														
GN1327A0	GUARNIZIONE RESISTENZA 100X22	1	PZ																														
RS1090A1	RESISTENZA CIRCOLARE D=230 3 SPIRE	1	PZ																														
SL1045A0	SILICONE ANTRACITE S53 80 ML	1	PZ																														
VI1220A1	VITE AUTOFILETTA NTE 4.2X11 TCS+ MARUTE	5	PZ																														
VM1794A0	FASCETTA 250X4.8 PA66 NERA	2	PZ																														
VM2103A0	PIASTRINA FERMAFASCE TTA	2	PZ																														
RC1170A	DADO M14 H=8 CH=22 INOX		KRC1170A	KIT 10 DADI M14 H8 CH22 INOX	<table border="1"> <thead> <tr> <th>Codice</th> <th>Descrizione</th> <th>Qtà</th> <th>UM</th> </tr> </thead> <tbody> <tr> <td>RC1170A1</td> <td>DADO M14 H=8 CH=22 INOX</td> <td>10</td> <td>PZ</td> </tr> </tbody> </table>	Codice	Descrizione	Qtà	UM	RC1170A1	DADO M14 H=8 CH=22 INOX	10	PZ																				
Codice	Descrizione	Qtà	UM																														
RC1170A1	DADO M14 H=8 CH=22 INOX	10	PZ																														
0H1990A	TUBO EST.UMIDITA' + RC1165A0		0H1990A1	TUBO EST.UMIDITA' + RC1165A0																													

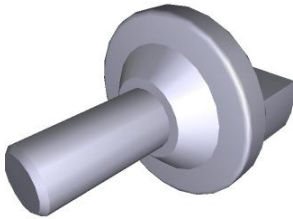
COMPONENTE			RICAMBIO																														
Codice	Descrizione	Immagine	Codice	Descrizione	Lista componenti																												
EL1055A	RIDUZIONE INTERMEDIA D10-D8		KEL1055A	KIT 10 PZ RIDUZIONE INTERMEDIA JG Ø10-Ø8	<table border="1"> <thead> <tr> <th>Codice</th> <th>Descrizione</th> <th>Qtà</th> <th>UM</th> </tr> </thead> <tbody> <tr> <td>EL1055A0</td> <td>RIDUZIONE INTERMEDIA D10-D8</td> <td>10</td> <td>PZ</td> </tr> </tbody> </table>	Codice	Descrizione	Qtà	UM	EL1055A0	RIDUZIONE INTERMEDIA D10-D8	10	PZ																				
Codice	Descrizione	Qtà	UM																														
EL1055A0	RIDUZIONE INTERMEDIA D10-D8	10	PZ																														
TB2034A	TB1815A - TUBO 8X4.75 PE TRASP. L=0,30M		KTB2597A KTB2529A KTB1959A	KIT TUBO Ø8 TRASP 500FT=150M TB1815 KIT 2M TUBO PE TRASPARENTE Ø8 TB1815 KIT TUBO PE 7,93X4,75 TRASPARENTE L=5	<table border="1"> <thead> <tr> <th>Codice</th> <th>Descrizione</th> <th>Qtà</th> <th>UM</th> </tr> </thead> <tbody> <tr> <td>TB1815A0</td> <td>TUBO PE 7,93X4,75 TRASPARENTE</td> <td>150</td> <td>M</td> </tr> <tr> <td>VM1059A1</td> <td>FILM TERMORETRA IBILE H800</td> <td>1.500</td> <td>M</td> </tr> </tbody> </table> <table border="1"> <thead> <tr> <th>Codice</th> <th>Descrizione</th> <th>Qtà</th> <th>UM</th> </tr> </thead> <tbody> <tr> <td>TB1815A0</td> <td>TUBO PE 7,93X4,75 TRASPARENTE</td> <td>2</td> <td>M</td> </tr> </tbody> </table> <table border="1"> <thead> <tr> <th>Codice</th> <th>Descrizione</th> <th>Qtà</th> <th>UM</th> </tr> </thead> <tbody> <tr> <td>TB1815A0</td> <td>TUBO PE 7,93X4,75 TRASPARENTE</td> <td>5</td> <td>M</td> </tr> </tbody> </table>	Codice	Descrizione	Qtà	UM	TB1815A0	TUBO PE 7,93X4,75 TRASPARENTE	150	M	VM1059A1	FILM TERMORETRA IBILE H800	1.500	M	Codice	Descrizione	Qtà	UM	TB1815A0	TUBO PE 7,93X4,75 TRASPARENTE	2	M	Codice	Descrizione	Qtà	UM	TB1815A0	TUBO PE 7,93X4,75 TRASPARENTE	5	M
Codice	Descrizione	Qtà	UM																														
TB1815A0	TUBO PE 7,93X4,75 TRASPARENTE	150	M																														
VM1059A1	FILM TERMORETRA IBILE H800	1.500	M																														
Codice	Descrizione	Qtà	UM																														
TB1815A0	TUBO PE 7,93X4,75 TRASPARENTE	2	M																														
Codice	Descrizione	Qtà	UM																														
TB1815A0	TUBO PE 7,93X4,75 TRASPARENTE	5	M																														
TB1098A	TUBO INTERNO UMIDITA XFT200 Ĩ16X1		TB1098A0	TUBO INTERNO UMIDITA XFT200 Ĩ16X1																													
TB2121A	CAMINO FUMI LM 800 Ĩ30X1		TB2121A0	CAMINO FUMI LM 800 Ĩ30X1																													

COMPONENTE			RICAMBIO																		
<i>Codice</i>	<i>Descrizione</i>	<i>Immagine</i>	<i>Codice</i>	<i>Descrizione</i>	<i>Lista componenti</i>																
0H1455A	STAFFA SOSTEGNO MUFFOLA		0H1455A2	STAFFA SOSTEGNO MUFFOLA																	
GRL1025A	GRIGLIA LAT DX/SX 4 600X400 LM ROSSELLA		KGRL1025A	KIT GRIGLIE LAT DX/SX 4 600X400 ROSSELLA	<table border="1"> <thead> <tr> <th>Codice</th> <th>Descrizione</th> <th>Qtà</th> <th>UM</th> </tr> </thead> <tbody> <tr> <td>GRL1025A1</td> <td>GRIGLIA LAT DX/SX 4 600X400 LM ROSSELLA</td> <td>2</td> <td>PZ</td> </tr> <tr> <td>IP1508A1</td> <td>POLISTIROLO PROFILO AD U 2000X60X60</td> <td>2</td> <td>M</td> </tr> <tr> <td>VM1059A1</td> <td>FILM TERMORETRA IBILE H800</td> <td>1.500</td> <td>M</td> </tr> </tbody> </table>	Codice	Descrizione	Qtà	UM	GRL1025A1	GRIGLIA LAT DX/SX 4 600X400 LM ROSSELLA	2	PZ	IP1508A1	POLISTIROLO PROFILO AD U 2000X60X60	2	M	VM1059A1	FILM TERMORETRA IBILE H800	1.500	M
Codice	Descrizione	Qtà	UM																		
GRL1025A1	GRIGLIA LAT DX/SX 4 600X400 LM ROSSELLA	2	PZ																		
IP1508A1	POLISTIROLO PROFILO AD U 2000X60X60	2	M																		
VM1059A1	FILM TERMORETRA IBILE H800	1.500	M																		
VM1815A	NOTTOLINO M6 CROMATO FISS. GRIGLIE		KVM1815A	KIT 10 NOTTOLINI MISS/MICRO/S.4/S.3 SVAS	<table border="1"> <thead> <tr> <th>Codice</th> <th>Descrizione</th> <th>Qtà</th> <th>UM</th> </tr> </thead> <tbody> <tr> <td>VM1815A0</td> <td>NOTTOLINO M6 CROMATO FISS. GRIGLIE</td> <td>10</td> <td>PZ</td> </tr> </tbody> </table>	Codice	Descrizione	Qtà	UM	VM1815A0	NOTTOLINO M6 CROMATO FISS. GRIGLIE	10	PZ								
Codice	Descrizione	Qtà	UM																		
VM1815A0	NOTTOLINO M6 CROMATO FISS. GRIGLIE	10	PZ																		
GN1354A	GN1110A-GUARNIZI ONE PORTA LM ROSSELLA		KGN1354A	KIT GUARNIZIONE PORTA ROSSELLA	<table border="1"> <thead> <tr> <th>Codice</th> <th>Descrizione</th> <th>Qtà</th> <th>UM</th> </tr> </thead> <tbody> <tr> <td>GN1110A2</td> <td>GUARNIZIONE PORTA PROFILO 248</td> <td>2.020</td> <td>M</td> </tr> </tbody> </table>	Codice	Descrizione	Qtà	UM	GN1110A2	GUARNIZIONE PORTA PROFILO 248	2.020	M								
Codice	Descrizione	Qtà	UM																		
GN1110A2	GUARNIZIONE PORTA PROFILO 248	2.020	M																		
0H4820A	STAFFA SOSTEGNO BULBO		0H4820A1	STAFFA SOSTEGNO BULBO																	

ASM2013D/0.D01 - Copertura esterna

FRONTE

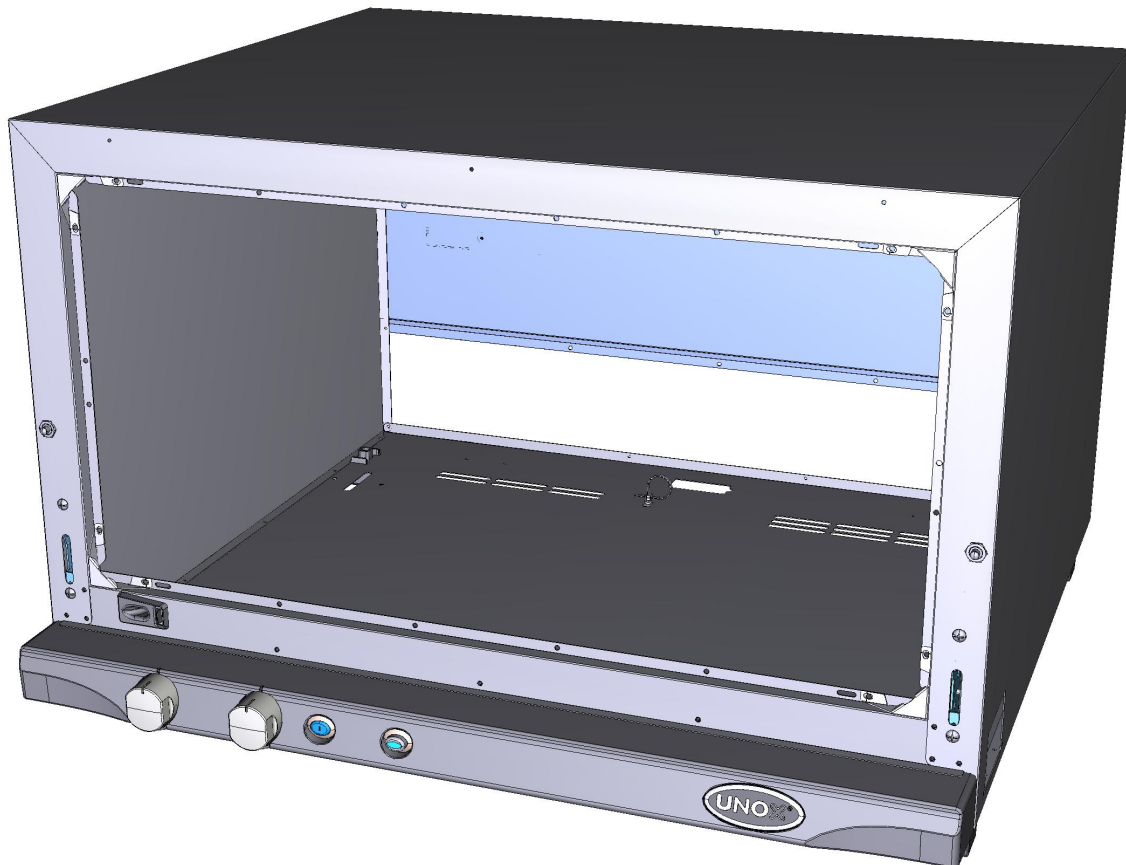



ASM2013D/0.D01 - Copertura esterna

RETRO



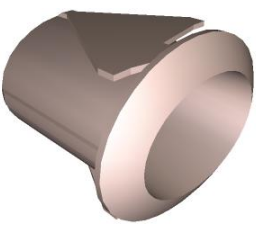

COMPONENTE			RICAMBIO										
Codice	Descrizione	Immagine	Codice	Descrizione	Lista componenti								
VM1951A	CUFFIA COPRICAMINO IP		KVM1065A	KIT CUFFIA COPRI CAMINO FUMI L.M.	<table border="1"> <thead> <tr> <th>Codice</th> <th>Descrizione</th> <th>Qtà</th> <th>UM</th> </tr> </thead> <tbody> <tr> <td>VM1065A0</td> <td>CUFFIA COPRI CAMINO FUMI L.M.</td> <td>1</td> <td>PZ</td> </tr> </tbody> </table>	Codice	Descrizione	Qtà	UM	VM1065A0	CUFFIA COPRI CAMINO FUMI L.M.	1	PZ
Codice	Descrizione	Qtà	UM										
VM1065A0	CUFFIA COPRI CAMINO FUMI L.M.	1	PZ										
0H1450A	ANGOLO FACCIATA MUFFOLA INOX XB-XV-XG		0H1450A0	ANGOLO FACCIATA MUFFOLA INOX XB-XV-XG									
PD1001A	PIEDINO 35X35 H26 PLASTICA+GOMMA GRIGIO		KPD1001A	KIT 4 PZ.PIEDINI 35X35 H26	<table border="1"> <thead> <tr> <th>Codice</th> <th>Descrizione</th> <th>Qtà</th> <th>UM</th> </tr> </thead> <tbody> <tr> <td>PD1001A0</td> <td>PIEDINO 35X35 H26 PLASTICA+GO MMA GRIGIO</td> <td>4</td> <td>PZ</td> </tr> </tbody> </table>	Codice	Descrizione	Qtà	UM	PD1001A0	PIEDINO 35X35 H26 PLASTICA+GO MMA GRIGIO	4	PZ
Codice	Descrizione	Qtà	UM										
PD1001A0	PIEDINO 35X35 H26 PLASTICA+GO MMA GRIGIO	4	PZ										
0D1285G	MANTELLO LM ROSSELLA		0D1285G0	MANTELLO LM ROSSELLA									
0E1081D	FONDO ESTERNO LM 800		0E1081D0	FONDO ESTERNO LM 800									

COMPONENTE			RICAMBIO																														
Codice	Descrizione	Immagine	Codice	Descrizione	Lista componenti																												
0F1095D	SCHIENA LM ROSSELLA		0F1095D0	SCHIENA LM ROSSELLA																													
CR1000A	ATTACCO CERNIERA PORTA FORNO RIBALTA		KCR1000A	KIT ATTACCO CERNIERA RIBALTA LM	<table border="1"> <thead> <tr> <th>Codice</th> <th>Descrizione</th> <th>Qtà</th> <th>UM</th> </tr> </thead> <tbody> <tr> <td>CR1000A0</td> <td>ATTACCO CERNIERA PORTA FORNO RIBALTA</td> <td>1</td> <td>PZ</td> </tr> <tr> <td>VI1875A0</td> <td>VITE M5X10 TC1/2T INOX</td> <td>2</td> <td>PZ</td> </tr> </tbody> </table>	Codice	Descrizione	Qtà	UM	CR1000A0	ATTACCO CERNIERA PORTA FORNO RIBALTA	1	PZ	VI1875A0	VITE M5X10 TC1/2T INOX	2	PZ																
Codice	Descrizione	Qtà	UM																														
CR1000A0	ATTACCO CERNIERA PORTA FORNO RIBALTA	1	PZ																														
VI1875A0	VITE M5X10 TC1/2T INOX	2	PZ																														
VE1295A	MICROINTERRUTTO RE PORTA MK 16A 230V UL		KVE1295A	KIT MICROINTERUTTOR E PORTA 16A 230V	<table border="1"> <thead> <tr> <th>Codice</th> <th>Descrizione</th> <th>Qtà</th> <th>UM</th> </tr> </thead> <tbody> <tr> <td>VE1295A0</td> <td>MICROINTERR UTTORE PORTA MK 16A 230V UL</td> <td>1</td> <td>PZ</td> </tr> </tbody> </table>	Codice	Descrizione	Qtà	UM	VE1295A0	MICROINTERR UTTORE PORTA MK 16A 230V UL	1	PZ																				
Codice	Descrizione	Qtà	UM																														
VE1295A0	MICROINTERR UTTORE PORTA MK 16A 230V UL	1	PZ																														
VM2019A	CRUSCOTTO COMANDI MANUAL LMISS800		KVM2019A	KIT CRUSCOTTO MANUAL LM800	<table border="1"> <thead> <tr> <th>Codice</th> <th>Descrizione</th> <th>Qtà</th> <th>UM</th> </tr> </thead> <tbody> <tr> <td>ED1070A0</td> <td>ETICHETTA UNOX ELLISSE 78X33 ARGENTO</td> <td>1</td> <td>PZ</td> </tr> <tr> <td>VE1170A0</td> <td>SUPPORTO D16 ELLITTICO NICHEL OPAC</td> <td>2</td> <td>PZ</td> </tr> <tr> <td>VE1530A0</td> <td>GEMMA ELLITTICA AZZURRA TERMOMETR O ORO</td> <td>1</td> <td>PZ</td> </tr> <tr> <td>VE1535A1</td> <td>LUCE SPIA LED BIANCO 230V</td> <td>1</td> <td>PZ</td> </tr> <tr> <td>VE1562A0</td> <td>PULSANTE UNIPOLORE N</td> <td>1</td> <td>PZ</td> </tr> <tr> <td>VM1762A0</td> <td>SUPPORTO LAMPADA INTERNO</td> <td>1</td> <td>PZ</td> </tr> </tbody> </table>	Codice	Descrizione	Qtà	UM	ED1070A0	ETICHETTA UNOX ELLISSE 78X33 ARGENTO	1	PZ	VE1170A0	SUPPORTO D16 ELLITTICO NICHEL OPAC	2	PZ	VE1530A0	GEMMA ELLITTICA AZZURRA TERMOMETR O ORO	1	PZ	VE1535A1	LUCE SPIA LED BIANCO 230V	1	PZ	VE1562A0	PULSANTE UNIPOLORE N	1	PZ	VM1762A0	SUPPORTO LAMPADA INTERNO	1	PZ
Codice	Descrizione	Qtà	UM																														
ED1070A0	ETICHETTA UNOX ELLISSE 78X33 ARGENTO	1	PZ																														
VE1170A0	SUPPORTO D16 ELLITTICO NICHEL OPAC	2	PZ																														
VE1530A0	GEMMA ELLITTICA AZZURRA TERMOMETR O ORO	1	PZ																														
VE1535A1	LUCE SPIA LED BIANCO 230V	1	PZ																														
VE1562A0	PULSANTE UNIPOLORE N	1	PZ																														
VM1762A0	SUPPORTO LAMPADA INTERNO	1	PZ																														

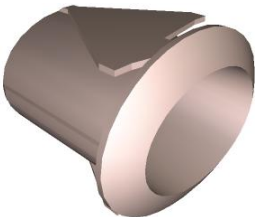
COMPONENTE			RICAMBIO																						
Codice	Descrizione	Immagine	Codice	Descrizione	Lista componenti																				
VM2019A	CRUSCOTTO COMANDI MANUAL LMISS800		KVM2019A	KIT CRUSCOTTO MANUAL LM800	<table border="1"> <thead> <tr> <th>Codice</th> <th>Descrizione</th> <th>Qtà</th> <th>UM</th> </tr> </thead> <tbody> <tr> <td>VM1775A0</td> <td>TASTO ARGENTO OPACO NUVOLETTA ORO</td> <td>1</td> <td>PZ</td> </tr> <tr> <td>VM1794A0</td> <td>FASCETTA 250X4.8 PA66 NERA</td> <td>2</td> <td>PZ</td> </tr> <tr> <td>VM2019A1</td> <td>CRUSCOTTO COMANDI MANUAL LMISS800</td> <td>1</td> <td>PZ</td> </tr> <tr> <td>VM2103A0</td> <td>PIASTRINA FERMAFASCE TTA</td> <td>2</td> <td>PZ</td> </tr> </tbody> </table>	Codice	Descrizione	Qtà	UM	VM1775A0	TASTO ARGENTO OPACO NUVOLETTA ORO	1	PZ	VM1794A0	FASCETTA 250X4.8 PA66 NERA	2	PZ	VM2019A1	CRUSCOTTO COMANDI MANUAL LMISS800	1	PZ	VM2103A0	PIASTRINA FERMAFASCE TTA	2	PZ
Codice	Descrizione	Qtà	UM																						
VM1775A0	TASTO ARGENTO OPACO NUVOLETTA ORO	1	PZ																						
VM1794A0	FASCETTA 250X4.8 PA66 NERA	2	PZ																						
VM2019A1	CRUSCOTTO COMANDI MANUAL LMISS800	1	PZ																						
VM2103A0	PIASTRINA FERMAFASCE TTA	2	PZ																						
ED1070A	ETICHETTA UNOX ELLISSE 78X33 ARGENTO		KED1070A	KIT 10 PZ.ETICHETTA UNOX ELLISSE 78X3	<table border="1"> <thead> <tr> <th>Codice</th> <th>Descrizione</th> <th>Qtà</th> <th>UM</th> </tr> </thead> <tbody> <tr> <td>ED1070A0</td> <td>ETICHETTA UNOX ELLISSE 78X33 ARGENTO</td> <td>10</td> <td>PZ</td> </tr> </tbody> </table>	Codice	Descrizione	Qtà	UM	ED1070A0	ETICHETTA UNOX ELLISSE 78X33 ARGENTO	10	PZ												
Codice	Descrizione	Qtà	UM																						
ED1070A0	ETICHETTA UNOX ELLISSE 78X33 ARGENTO	10	PZ																						
VE1170A	SUPPORTO D16 ELLITTICO NICHEL OPACO		KVE0108A	KIT TASTO 0 - 1 ARGENTO OPACO	<table border="1"> <thead> <tr> <th>Codice</th> <th>Descrizione</th> <th>Qtà</th> <th>UM</th> </tr> </thead> <tbody> <tr> <td>VE1170A0</td> <td>SUPPORTO D16 ELLITTICO NICHEL OPAC</td> <td>1</td> <td>PZ</td> </tr> <tr> <td>VE1561A0</td> <td>INTERRUTTO RE BIPOLARE NA/NA</td> <td>1</td> <td>PZ</td> </tr> <tr> <td>VM1761A0</td> <td>SUPPORTO ELLITTICO NERO</td> <td>1</td> <td>PZ</td> </tr> <tr> <td>VM1776A0</td> <td>TASTO ARGENTO OPACO "0-1" ORO</td> <td>1</td> <td>PZ</td> </tr> </tbody> </table>	Codice	Descrizione	Qtà	UM	VE1170A0	SUPPORTO D16 ELLITTICO NICHEL OPAC	1	PZ	VE1561A0	INTERRUTTO RE BIPOLARE NA/NA	1	PZ	VM1761A0	SUPPORTO ELLITTICO NERO	1	PZ	VM1776A0	TASTO ARGENTO OPACO "0-1" ORO	1	PZ
Codice	Descrizione	Qtà	UM																						
VE1170A0	SUPPORTO D16 ELLITTICO NICHEL OPAC	1	PZ																						
VE1561A0	INTERRUTTO RE BIPOLARE NA/NA	1	PZ																						
VM1761A0	SUPPORTO ELLITTICO NERO	1	PZ																						
VM1776A0	TASTO ARGENTO OPACO "0-1" ORO	1	PZ																						
			KLP1014A	KIT RICAMBIO SPIA AZZURRA SINUSOID	<table border="1"> <thead> <tr> <th>Codice</th> <th>Descrizione</th> <th>Qtà</th> <th>UM</th> </tr> </thead> <tbody> <tr> <td>VE1170A0</td> <td>SUPPORTO D16 ELLITTICO NICHEL OPAC</td> <td>2</td> <td>PZ</td> </tr> <tr> <td>VE1535A1</td> <td>LUCE SPIA LED BIANCO 230V</td> <td>2</td> <td>PZ</td> </tr> <tr> <td>VE1585A0</td> <td>GEMMA ELLITTICA AZZURRA SINUSOIDE ORO</td> <td>2</td> <td>PZ</td> </tr> </tbody> </table>	Codice	Descrizione	Qtà	UM	VE1170A0	SUPPORTO D16 ELLITTICO NICHEL OPAC	2	PZ	VE1535A1	LUCE SPIA LED BIANCO 230V	2	PZ	VE1585A0	GEMMA ELLITTICA AZZURRA SINUSOIDE ORO	2	PZ				
Codice	Descrizione	Qtà	UM																						
VE1170A0	SUPPORTO D16 ELLITTICO NICHEL OPAC	2	PZ																						
VE1535A1	LUCE SPIA LED BIANCO 230V	2	PZ																						
VE1585A0	GEMMA ELLITTICA AZZURRA SINUSOIDE ORO	2	PZ																						

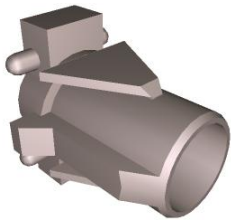
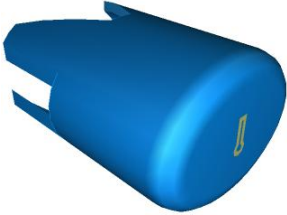
COMPONENTE			RICAMBIO																						
Codice	Descrizione	Immagine	Codice	Descrizione	Lista componenti																				
VE1170A	SUPPORTO D16 ELLITTICO NICHEL OPACO		KLP1014A	KIT RICAMBIO SPIA AZZURRA SINUSOID	<table border="1"> <thead> <tr> <th>Codice</th> <th>Descrizione</th> <th>Qtà</th> <th>UM</th> </tr> </thead> <tbody> <tr> <td>VM1762A0</td> <td>SUPPORTO LAMPADA INTERNO</td> <td>2</td> <td>PZ</td> </tr> <tr> <td>VM2009A0</td> <td>SUPPORTO ELLITTICO D16 ARGENTO</td> <td>1</td> <td>PZ</td> </tr> </tbody> </table>	Codice	Descrizione	Qtà	UM	VM1762A0	SUPPORTO LAMPADA INTERNO	2	PZ	VM2009A0	SUPPORTO ELLITTICO D16 ARGENTO	1	PZ								
			Codice	Descrizione	Qtà	UM																			
			VM1762A0	SUPPORTO LAMPADA INTERNO	2	PZ																			
			VM2009A0	SUPPORTO ELLITTICO D16 ARGENTO	1	PZ																			
			KLP1012A	KIT SPIA AZZURRA TERMOSTATO	<table border="1"> <thead> <tr> <th>Codice</th> <th>Descrizione</th> <th>Qtà</th> <th>UM</th> </tr> </thead> <tbody> <tr> <td>VE1170A0</td> <td>SUPPORTO D16 ELLITTICO NICHEL OPAC</td> <td>1</td> <td>PZ</td> </tr> <tr> <td>VE1530A0</td> <td>GEMMA ELLITTICA AZZURRA TERMOMETR O ORO</td> <td>1</td> <td>PZ</td> </tr> <tr> <td>VE1535A1</td> <td>LUCE SPIA LED BIANCO 230V</td> <td>1</td> <td>PZ</td> </tr> <tr> <td>VM1762A0</td> <td>SUPPORTO LAMPADA INTERNO</td> <td>1</td> <td>PZ</td> </tr> </tbody> </table>	Codice	Descrizione	Qtà	UM	VE1170A0	SUPPORTO D16 ELLITTICO NICHEL OPAC	1	PZ	VE1530A0	GEMMA ELLITTICA AZZURRA TERMOMETR O ORO	1	PZ	VE1535A1	LUCE SPIA LED BIANCO 230V	1	PZ	VM1762A0	SUPPORTO LAMPADA INTERNO	1	PZ
			Codice	Descrizione	Qtà	UM																			
			VE1170A0	SUPPORTO D16 ELLITTICO NICHEL OPAC	1	PZ																			
			VE1530A0	GEMMA ELLITTICA AZZURRA TERMOMETR O ORO	1	PZ																			
			VE1535A1	LUCE SPIA LED BIANCO 230V	1	PZ																			
			VM1762A0	SUPPORTO LAMPADA INTERNO	1	PZ																			
			KLP1011A	KIT SPIA TERMOSTATO SUPP.NICHELATO 110V	<table border="1"> <thead> <tr> <th>Codice</th> <th>Descrizione</th> <th>Qtà</th> <th>UM</th> </tr> </thead> <tbody> <tr> <td>VE1170A0</td> <td>SUPPORTO D16 ELLITTICO NICHEL OPAC</td> <td>1</td> <td>PZ</td> </tr> <tr> <td>VE1530A0</td> <td>GEMMA ELLITTICA AZZURRA TERMOMETR O ORO</td> <td>1</td> <td>PZ</td> </tr> <tr> <td>VE1535A1</td> <td>LUCE SPIA LED BIANCO 230V</td> <td>1</td> <td>PZ</td> </tr> <tr> <td>VM1762A0</td> <td>SUPPORTO LAMPADA INTERNO</td> <td>1</td> <td>PZ</td> </tr> </tbody> </table>	Codice	Descrizione	Qtà	UM	VE1170A0	SUPPORTO D16 ELLITTICO NICHEL OPAC	1	PZ	VE1530A0	GEMMA ELLITTICA AZZURRA TERMOMETR O ORO	1	PZ	VE1535A1	LUCE SPIA LED BIANCO 230V	1	PZ	VM1762A0	SUPPORTO LAMPADA INTERNO	1	PZ
			Codice	Descrizione	Qtà	UM																			
VE1170A0	SUPPORTO D16 ELLITTICO NICHEL OPAC	1	PZ																						
VE1530A0	GEMMA ELLITTICA AZZURRA TERMOMETR O ORO	1	PZ																						
VE1535A1	LUCE SPIA LED BIANCO 230V	1	PZ																						
VM1762A0	SUPPORTO LAMPADA INTERNO	1	PZ																						
KLP1010A	KIT SPIA VERDE TERMOSTATO	<table border="1"> <thead> <tr> <th>Codice</th> <th>Descrizione</th> <th>Qtà</th> <th>UM</th> </tr> </thead> <tbody> <tr> <td>VE1170A0</td> <td>SUPPORTO D16 ELLITTICO NICHEL OPAC</td> <td>1</td> <td>PZ</td> </tr> <tr> <td>VE1535A1</td> <td>LUCE SPIA LED BIANCO 230V</td> <td>1</td> <td>PZ</td> </tr> <tr> <td>VM1762A0</td> <td>SUPPORTO LAMPADA INTERNO</td> <td>1</td> <td>PZ</td> </tr> <tr> <td>VM1764A0</td> <td>GEMMA VERDE TERMOMETR O ORO</td> <td>1</td> <td>PZ</td> </tr> </tbody> </table>	Codice	Descrizione	Qtà	UM	VE1170A0	SUPPORTO D16 ELLITTICO NICHEL OPAC	1	PZ	VE1535A1	LUCE SPIA LED BIANCO 230V	1	PZ	VM1762A0	SUPPORTO LAMPADA INTERNO	1	PZ	VM1764A0	GEMMA VERDE TERMOMETR O ORO	1	PZ			
Codice	Descrizione	Qtà	UM																						
VE1170A0	SUPPORTO D16 ELLITTICO NICHEL OPAC	1	PZ																						
VE1535A1	LUCE SPIA LED BIANCO 230V	1	PZ																						
VM1762A0	SUPPORTO LAMPADA INTERNO	1	PZ																						
VM1764A0	GEMMA VERDE TERMOMETR O ORO	1	PZ																						

COMPONENTE			RICAMBIO																																										
Codice	Descrizione	Immagine	Codice	Descrizione	Lista componenti																																								
VM1762A	SUPPORTO LAMPADA INTERNO		KVM1762A	KIT SUPPORTO INTERNO LAMPADA	<table border="1"> <thead> <tr> <th>Codice</th> <th>Descrizione</th> <th>Qtà</th> <th>UM</th> </tr> </thead> <tbody> <tr> <td>VM1762A0</td> <td>SUPPORTO LAMPADA INTERNO</td> <td>1</td> <td>PZ</td> </tr> </tbody> </table>	Codice	Descrizione	Qtà	UM	VM1762A0	SUPPORTO LAMPADA INTERNO	1	PZ																																
Codice	Descrizione	Qtà	UM																																										
VM1762A0	SUPPORTO LAMPADA INTERNO	1	PZ																																										
VE1530A	GEMMA ELLITTICA AZZURRA TERMOMETRO ORO		KLP1012A	KIT SPIA AZZURRA TERMOSTATO	<table border="1"> <thead> <tr> <th>Codice</th> <th>Descrizione</th> <th>Qtà</th> <th>UM</th> </tr> </thead> <tbody> <tr> <td>VE1170A0</td> <td>SUPPORTO D16 ELLITTICO NICHEL OPAC</td> <td>1</td> <td>PZ</td> </tr> <tr> <td>VE1530A0</td> <td>GEMMA ELLITTICA AZZURRA TERMOMETR O ORO</td> <td>1</td> <td>PZ</td> </tr> <tr> <td>VE1535A1</td> <td>LUCE SPIA LED BIANCO 230V</td> <td>1</td> <td>PZ</td> </tr> <tr> <td>VM1762A0</td> <td>SUPPORTO LAMPADA INTERNO</td> <td>1</td> <td>PZ</td> </tr> </tbody> </table>	Codice	Descrizione	Qtà	UM	VE1170A0	SUPPORTO D16 ELLITTICO NICHEL OPAC	1	PZ	VE1530A0	GEMMA ELLITTICA AZZURRA TERMOMETR O ORO	1	PZ	VE1535A1	LUCE SPIA LED BIANCO 230V	1	PZ	VM1762A0	SUPPORTO LAMPADA INTERNO	1	PZ																				
Codice	Descrizione	Qtà	UM																																										
VE1170A0	SUPPORTO D16 ELLITTICO NICHEL OPAC	1	PZ																																										
VE1530A0	GEMMA ELLITTICA AZZURRA TERMOMETR O ORO	1	PZ																																										
VE1535A1	LUCE SPIA LED BIANCO 230V	1	PZ																																										
VM1762A0	SUPPORTO LAMPADA INTERNO	1	PZ																																										
VE1535A	LUCE SPIA LED BIANCO 230V		KVE1535A KVE0105A KVE0104A	KIT 1 PZ.LUCE SPIA LED KIT RICAMBIO SPIA VERDE NUVOLETTA KIT SPIA VERDE NEUTRA	<table border="1"> <thead> <tr> <th>Codice</th> <th>Descrizione</th> <th>Qtà</th> <th>UM</th> </tr> </thead> <tbody> <tr> <td>VE1535A1</td> <td>LUCE SPIA LED BIANCO 230V</td> <td>1</td> <td>PZ</td> </tr> </tbody> </table> <table border="1"> <thead> <tr> <th>Codice</th> <th>Descrizione</th> <th>Qtà</th> <th>UM</th> </tr> </thead> <tbody> <tr> <td>VE1535A1</td> <td>LUCE SPIA LED BIANCO 230V</td> <td>1</td> <td>PZ</td> </tr> <tr> <td>VM1761A0</td> <td>SUPPORTO ELLITTICO NERO</td> <td>1</td> <td>PZ</td> </tr> <tr> <td>VM1762A0</td> <td>SUPPORTO LAMPADA INTERNO</td> <td>1</td> <td>PZ</td> </tr> <tr> <td>VM1903A0</td> <td>GEMMA VERDE NUVOLETTA ORO</td> <td>1</td> <td>PZ</td> </tr> </tbody> </table> <table border="1"> <thead> <tr> <th>Codice</th> <th>Descrizione</th> <th>Qtà</th> <th>UM</th> </tr> </thead> <tbody> <tr> <td>VE1535A1</td> <td>LUCE SPIA LED BIANCO 230V</td> <td>1</td> <td>PZ</td> </tr> <tr> <td>VM1761A0</td> <td>SUPPORTO ELLITTICO NERO</td> <td>1</td> <td>PZ</td> </tr> </tbody> </table>	Codice	Descrizione	Qtà	UM	VE1535A1	LUCE SPIA LED BIANCO 230V	1	PZ	Codice	Descrizione	Qtà	UM	VE1535A1	LUCE SPIA LED BIANCO 230V	1	PZ	VM1761A0	SUPPORTO ELLITTICO NERO	1	PZ	VM1762A0	SUPPORTO LAMPADA INTERNO	1	PZ	VM1903A0	GEMMA VERDE NUVOLETTA ORO	1	PZ	Codice	Descrizione	Qtà	UM	VE1535A1	LUCE SPIA LED BIANCO 230V	1	PZ	VM1761A0	SUPPORTO ELLITTICO NERO	1	PZ
Codice	Descrizione	Qtà	UM																																										
VE1535A1	LUCE SPIA LED BIANCO 230V	1	PZ																																										
Codice	Descrizione	Qtà	UM																																										
VE1535A1	LUCE SPIA LED BIANCO 230V	1	PZ																																										
VM1761A0	SUPPORTO ELLITTICO NERO	1	PZ																																										
VM1762A0	SUPPORTO LAMPADA INTERNO	1	PZ																																										
VM1903A0	GEMMA VERDE NUVOLETTA ORO	1	PZ																																										
Codice	Descrizione	Qtà	UM																																										
VE1535A1	LUCE SPIA LED BIANCO 230V	1	PZ																																										
VM1761A0	SUPPORTO ELLITTICO NERO	1	PZ																																										

COMPONENTE			RICAMBIO																						
Codice	Descrizione	Immagine	Codice	Descrizione	Lista componenti																				
VE1535A	LUCE SPIA LED BIANCO 230V		KVE0104A	KIT SPIA VERDE NEUTRA	<table border="1"> <thead> <tr> <th>Codice</th> <th>Descrizione</th> <th>Qtà</th> <th>UM</th> </tr> </thead> <tbody> <tr> <td>VM1762A0</td> <td>SUPPORTO LAMPADA INTERNO</td> <td>1</td> <td>PZ</td> </tr> <tr> <td>VM1902A0</td> <td>GEMMA VERDE NEUTR</td> <td>1</td> <td>PZ</td> </tr> </tbody> </table>	Codice	Descrizione	Qtà	UM	VM1762A0	SUPPORTO LAMPADA INTERNO	1	PZ	VM1902A0	GEMMA VERDE NEUTR	1	PZ								
			Codice	Descrizione	Qtà	UM																			
			VM1762A0	SUPPORTO LAMPADA INTERNO	1	PZ																			
			VM1902A0	GEMMA VERDE NEUTR	1	PZ																			
			KVE0102A	KIT GEMMA FIAMMA	<table border="1"> <thead> <tr> <th>Codice</th> <th>Descrizione</th> <th>Qtà</th> <th>UM</th> </tr> </thead> <tbody> <tr> <td>VE1535A1</td> <td>LUCE SPIA LED BIANCO 230V</td> <td>1</td> <td>PZ</td> </tr> <tr> <td>VM1761A0</td> <td>SUPPORTO ELLITTICO NERO</td> <td>1</td> <td>PZ</td> </tr> <tr> <td>VM1762A0</td> <td>SUPPORTO LAMPADA INTERNO</td> <td>1</td> <td>PZ</td> </tr> <tr> <td>VM1767A0</td> <td>GEMMA VERDE FIAMMA ORO</td> <td>1</td> <td>PZ</td> </tr> </tbody> </table>	Codice	Descrizione	Qtà	UM	VE1535A1	LUCE SPIA LED BIANCO 230V	1	PZ	VM1761A0	SUPPORTO ELLITTICO NERO	1	PZ	VM1762A0	SUPPORTO LAMPADA INTERNO	1	PZ	VM1767A0	GEMMA VERDE FIAMMA ORO	1	PZ
			Codice	Descrizione	Qtà	UM																			
			VE1535A1	LUCE SPIA LED BIANCO 230V	1	PZ																			
			VM1761A0	SUPPORTO ELLITTICO NERO	1	PZ																			
			VM1762A0	SUPPORTO LAMPADA INTERNO	1	PZ																			
			VM1767A0	GEMMA VERDE FIAMMA ORO	1	PZ																			
			KVE0101A	KIT GEMMA VERDE SINUSOIDE	<table border="1"> <thead> <tr> <th>Codice</th> <th>Descrizione</th> <th>Qtà</th> <th>UM</th> </tr> </thead> <tbody> <tr> <td>VE1535A1</td> <td>LUCE SPIA LED BIANCO 230V</td> <td>1</td> <td>PZ</td> </tr> <tr> <td>VM1761A0</td> <td>SUPPORTO ELLITTICO NERO</td> <td>1</td> <td>PZ</td> </tr> <tr> <td>VM1762A0</td> <td>SUPPORTO LAMPADA INTERNO</td> <td>1</td> <td>PZ</td> </tr> <tr> <td>VM1765A0</td> <td>GEMMA VERDE SINUSOIDE ORO</td> <td>1</td> <td>PZ</td> </tr> </tbody> </table>	Codice	Descrizione	Qtà	UM	VE1535A1	LUCE SPIA LED BIANCO 230V	1	PZ	VM1761A0	SUPPORTO ELLITTICO NERO	1	PZ	VM1762A0	SUPPORTO LAMPADA INTERNO	1	PZ	VM1765A0	GEMMA VERDE SINUSOIDE ORO	1	PZ
			Codice	Descrizione	Qtà	UM																			
VE1535A1	LUCE SPIA LED BIANCO 230V	1	PZ																						
VM1761A0	SUPPORTO ELLITTICO NERO	1	PZ																						
VM1762A0	SUPPORTO LAMPADA INTERNO	1	PZ																						
VM1765A0	GEMMA VERDE SINUSOIDE ORO	1	PZ																						
KVE0100A	KIT GEMMA TERMOMETRO	<table border="1"> <thead> <tr> <th>Codice</th> <th>Descrizione</th> <th>Qtà</th> <th>UM</th> </tr> </thead> <tbody> <tr> <td>VE1530A0</td> <td>GEMMA ELLITTICA AZZURRA TERMOMETR O ORO</td> <td>1</td> <td>PZ</td> </tr> <tr> <td>VE1535A1</td> <td>LUCE SPIA LED BIANCO 230V</td> <td>1</td> <td>PZ</td> </tr> <tr> <td>VM1761A0</td> <td>SUPPORTO ELLITTICO NERO</td> <td>1</td> <td>PZ</td> </tr> <tr> <td>VM1762A0</td> <td>SUPPORTO LAMPADA INTERNO</td> <td>1</td> <td>PZ</td> </tr> </tbody> </table>	Codice	Descrizione	Qtà	UM	VE1530A0	GEMMA ELLITTICA AZZURRA TERMOMETR O ORO	1	PZ	VE1535A1	LUCE SPIA LED BIANCO 230V	1	PZ	VM1761A0	SUPPORTO ELLITTICO NERO	1	PZ	VM1762A0	SUPPORTO LAMPADA INTERNO	1	PZ			
Codice	Descrizione	Qtà	UM																						
VE1530A0	GEMMA ELLITTICA AZZURRA TERMOMETR O ORO	1	PZ																						
VE1535A1	LUCE SPIA LED BIANCO 230V	1	PZ																						
VM1761A0	SUPPORTO ELLITTICO NERO	1	PZ																						
VM1762A0	SUPPORTO LAMPADA INTERNO	1	PZ																						

COMPONENTE			RICAMBIO																																						
Codice	Descrizione	Immagine	Codice	Descrizione	Lista componenti																																				
VE1535A	LUCE SPIA LED BIANCO 230V		KVE0011A	KIT MANOPOLE - GEMME XP	<table border="1"> <thead> <tr> <th>Codice</th> <th>Descrizione</th> <th>Qtà</th> <th>UM</th> </tr> </thead> <tbody> <tr> <td>MN1105A0</td> <td>MANOPOLA TERMOSTATO 120-400C.XP</td> <td>1</td> <td>PZ</td> </tr> <tr> <td>MN1110A0</td> <td>GHIERA CON INDICE STAMPATO XP</td> <td>1</td> <td>PZ</td> </tr> <tr> <td>VE1530A0</td> <td>GEMMA ELLITTICA AZZURRA TERMOMETR O ORO</td> <td>1</td> <td>PZ</td> </tr> <tr> <td>VE1535A1</td> <td>LUCE SPIA LED BIANCO 230V</td> <td>1</td> <td>PZ</td> </tr> <tr> <td>VE1561A0</td> <td>INTERRUTTO RE BIPOLARE NA/NA</td> <td>1</td> <td>PZ</td> </tr> <tr> <td>VM1761A0</td> <td>SUPPORTO ELLITTICO NERO</td> <td>2</td> <td>PZ</td> </tr> <tr> <td>VM1762A0</td> <td>SUPPORTO LAMPADA INTERNO</td> <td>1</td> <td>PZ</td> </tr> <tr> <td>VM1776A0</td> <td>TASTO ARGENTO OPACO "0-1" ORO</td> <td>1</td> <td>PZ</td> </tr> </tbody> </table>	Codice	Descrizione	Qtà	UM	MN1105A0	MANOPOLA TERMOSTATO 120-400C.XP	1	PZ	MN1110A0	GHIERA CON INDICE STAMPATO XP	1	PZ	VE1530A0	GEMMA ELLITTICA AZZURRA TERMOMETR O ORO	1	PZ	VE1535A1	LUCE SPIA LED BIANCO 230V	1	PZ	VE1561A0	INTERRUTTO RE BIPOLARE NA/NA	1	PZ	VM1761A0	SUPPORTO ELLITTICO NERO	2	PZ	VM1762A0	SUPPORTO LAMPADA INTERNO	1	PZ	VM1776A0	TASTO ARGENTO OPACO "0-1" ORO	1	PZ
			Codice	Descrizione	Qtà	UM																																			
MN1105A0	MANOPOLA TERMOSTATO 120-400C.XP	1	PZ																																						
MN1110A0	GHIERA CON INDICE STAMPATO XP	1	PZ																																						
VE1530A0	GEMMA ELLITTICA AZZURRA TERMOMETR O ORO	1	PZ																																						
VE1535A1	LUCE SPIA LED BIANCO 230V	1	PZ																																						
VE1561A0	INTERRUTTO RE BIPOLARE NA/NA	1	PZ																																						
VM1761A0	SUPPORTO ELLITTICO NERO	2	PZ																																						
VM1762A0	SUPPORTO LAMPADA INTERNO	1	PZ																																						
VM1776A0	TASTO ARGENTO OPACO "0-1" ORO	1	PZ																																						
KVE0008A	KIT GEMME AZZURRE XL	<table border="1"> <thead> <tr> <th>Codice</th> <th>Descrizione</th> <th>Qtà</th> <th>UM</th> </tr> </thead> <tbody> <tr> <td>VE1530A0</td> <td>GEMMA ELLITTICA AZZURRA TERMOMETR O ORO</td> <td>1</td> <td>PZ</td> </tr> <tr> <td>VE1535A1</td> <td>LUCE SPIA LED BIANCO 230V</td> <td>1</td> <td>PZ</td> </tr> <tr> <td>VE1561A0</td> <td>INTERRUTTO RE BIPOLARE NA/NA</td> <td>1</td> <td>PZ</td> </tr> <tr> <td>VE1562A0</td> <td>PULSANTE UNIPOLARE N</td> <td>1</td> <td>PZ</td> </tr> <tr> <td>VM1761A0</td> <td>SUPPORTO ELLITTICO NERO</td> <td>3</td> <td>PZ</td> </tr> <tr> <td>VM1762A0</td> <td>SUPPORTO LAMPADA INTERNO</td> <td>1</td> <td>PZ</td> </tr> <tr> <td>VM1775A0</td> <td>TASTO ARGENTO OPACO NUVOLETTA ORO</td> <td>1</td> <td>PZ</td> </tr> <tr> <td>VM1776A0</td> <td>TASTO ARGENTO OPACO "0-1" ORO</td> <td>1</td> <td>PZ</td> </tr> </tbody> </table>	Codice	Descrizione	Qtà	UM	VE1530A0	GEMMA ELLITTICA AZZURRA TERMOMETR O ORO	1	PZ	VE1535A1	LUCE SPIA LED BIANCO 230V	1	PZ	VE1561A0	INTERRUTTO RE BIPOLARE NA/NA	1	PZ	VE1562A0	PULSANTE UNIPOLARE N	1	PZ	VM1761A0	SUPPORTO ELLITTICO NERO	3	PZ	VM1762A0	SUPPORTO LAMPADA INTERNO	1	PZ	VM1775A0	TASTO ARGENTO OPACO NUVOLETTA ORO	1	PZ	VM1776A0	TASTO ARGENTO OPACO "0-1" ORO	1	PZ			
Codice	Descrizione	Qtà	UM																																						
VE1530A0	GEMMA ELLITTICA AZZURRA TERMOMETR O ORO	1	PZ																																						
VE1535A1	LUCE SPIA LED BIANCO 230V	1	PZ																																						
VE1561A0	INTERRUTTO RE BIPOLARE NA/NA	1	PZ																																						
VE1562A0	PULSANTE UNIPOLARE N	1	PZ																																						
VM1761A0	SUPPORTO ELLITTICO NERO	3	PZ																																						
VM1762A0	SUPPORTO LAMPADA INTERNO	1	PZ																																						
VM1775A0	TASTO ARGENTO OPACO NUVOLETTA ORO	1	PZ																																						
VM1776A0	TASTO ARGENTO OPACO "0-1" ORO	1	PZ																																						

COMPONENTE			RICAMBIO																																																		
Codice	Descrizione	Immagine	Codice	Descrizione	Lista componenti																																																
VE1535A	LUCE SPIA LED BIANCO 230V		KVE0007A	KIT GEMME XF-XG	<table border="1"> <thead> <tr> <th>Codice</th> <th>Descrizione</th> <th>Qtà</th> <th>UM</th> </tr> </thead> <tbody> <tr> <td>VE1530A0</td> <td>GEMMA ELLITTICA AZZURRA TERMOMETR O ORO</td> <td>1</td> <td>PZ</td> </tr> <tr> <td>VE1535A1</td> <td>LUCE SPIA LED BIANCO 230V</td> <td>1</td> <td>PZ</td> </tr> <tr> <td>VE1562A0</td> <td>PULSANTE UNIPOLARE N</td> <td>1</td> <td>PZ</td> </tr> <tr> <td>VE1585A0</td> <td>GEMMA ELLITTICA AZZURRA SINUSOIDE ORO</td> <td>1</td> <td>PZ</td> </tr> <tr> <td>VM1761A0</td> <td>SUPPORTO ELLITTICO NERO</td> <td>5</td> <td>PZ</td> </tr> <tr> <td>VM1762A0</td> <td>SUPPORTO LAMPADA INTERNO</td> <td>4</td> <td>PZ</td> </tr> <tr> <td>VM1767A0</td> <td>GEMMA VERDE FIAMMA ORO</td> <td>1</td> <td>PZ</td> </tr> <tr> <td>VM1774A0</td> <td>TASTO ARGENTO OPACO FIAMMA ORO</td> <td>1</td> <td>PZ</td> </tr> <tr> <td>VM1775A0</td> <td>TASTO ARGENTO OPACO NUVOLETTA ORO</td> <td>1</td> <td>PZ</td> </tr> <tr> <td>VM1902A0</td> <td>GEMMA VERDE NEUTR</td> <td>1</td> <td>PZ</td> </tr> <tr> <td>VM1903A0</td> <td>GEMMA VERDE NUVOLETTA ORO</td> <td>1</td> <td>PZ</td> </tr> </tbody> </table>	Codice	Descrizione	Qtà	UM	VE1530A0	GEMMA ELLITTICA AZZURRA TERMOMETR O ORO	1	PZ	VE1535A1	LUCE SPIA LED BIANCO 230V	1	PZ	VE1562A0	PULSANTE UNIPOLARE N	1	PZ	VE1585A0	GEMMA ELLITTICA AZZURRA SINUSOIDE ORO	1	PZ	VM1761A0	SUPPORTO ELLITTICO NERO	5	PZ	VM1762A0	SUPPORTO LAMPADA INTERNO	4	PZ	VM1767A0	GEMMA VERDE FIAMMA ORO	1	PZ	VM1774A0	TASTO ARGENTO OPACO FIAMMA ORO	1	PZ	VM1775A0	TASTO ARGENTO OPACO NUVOLETTA ORO	1	PZ	VM1902A0	GEMMA VERDE NEUTR	1	PZ	VM1903A0	GEMMA VERDE NUVOLETTA ORO	1	PZ
			Codice	Descrizione	Qtà	UM																																															
VE1530A0	GEMMA ELLITTICA AZZURRA TERMOMETR O ORO	1	PZ																																																		
VE1535A1	LUCE SPIA LED BIANCO 230V	1	PZ																																																		
VE1562A0	PULSANTE UNIPOLARE N	1	PZ																																																		
VE1585A0	GEMMA ELLITTICA AZZURRA SINUSOIDE ORO	1	PZ																																																		
VM1761A0	SUPPORTO ELLITTICO NERO	5	PZ																																																		
VM1762A0	SUPPORTO LAMPADA INTERNO	4	PZ																																																		
VM1767A0	GEMMA VERDE FIAMMA ORO	1	PZ																																																		
VM1774A0	TASTO ARGENTO OPACO FIAMMA ORO	1	PZ																																																		
VM1775A0	TASTO ARGENTO OPACO NUVOLETTA ORO	1	PZ																																																		
VM1902A0	GEMMA VERDE NEUTR	1	PZ																																																		
VM1903A0	GEMMA VERDE NUVOLETTA ORO	1	PZ																																																		
KLP1014A	KIT RICAMBIO SPIA AZZURRA SINUSOID	<table border="1"> <thead> <tr> <th>Codice</th> <th>Descrizione</th> <th>Qtà</th> <th>UM</th> </tr> </thead> <tbody> <tr> <td>VE1170A0</td> <td>SUPPORTO D16 ELLITTICO NICHEL OPAC</td> <td>2</td> <td>PZ</td> </tr> <tr> <td>VE1535A1</td> <td>LUCE SPIA LED BIANCO 230V</td> <td>2</td> <td>PZ</td> </tr> <tr> <td>VE1585A0</td> <td>GEMMA ELLITTICA AZZURRA SINUSOIDE ORO</td> <td>2</td> <td>PZ</td> </tr> <tr> <td>VM1762A0</td> <td>SUPPORTO LAMPADA INTERNO</td> <td>2</td> <td>PZ</td> </tr> <tr> <td>VM2009A0</td> <td>SUPPORTO ELLITTICO D16 ARGENTO</td> <td>1</td> <td>PZ</td> </tr> </tbody> </table>	Codice	Descrizione	Qtà	UM	VE1170A0	SUPPORTO D16 ELLITTICO NICHEL OPAC	2	PZ	VE1535A1	LUCE SPIA LED BIANCO 230V	2	PZ	VE1585A0	GEMMA ELLITTICA AZZURRA SINUSOIDE ORO	2	PZ	VM1762A0	SUPPORTO LAMPADA INTERNO	2	PZ	VM2009A0	SUPPORTO ELLITTICO D16 ARGENTO	1	PZ																											
Codice	Descrizione	Qtà	UM																																																		
VE1170A0	SUPPORTO D16 ELLITTICO NICHEL OPAC	2	PZ																																																		
VE1535A1	LUCE SPIA LED BIANCO 230V	2	PZ																																																		
VE1585A0	GEMMA ELLITTICA AZZURRA SINUSOIDE ORO	2	PZ																																																		
VM1762A0	SUPPORTO LAMPADA INTERNO	2	PZ																																																		
VM2009A0	SUPPORTO ELLITTICO D16 ARGENTO	1	PZ																																																		

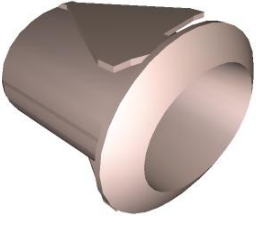
COMPONENTE			RICAMBIO																						
Codice	Descrizione	Immagine	Codice	Descrizione	Lista componenti																				
VE1535A	LUCE SPIA LED BIANCO 230V		KLP1012A	KIT SPIA AZZURRA TERMOSTATO	<table border="1"> <thead> <tr> <th>Codice</th> <th>Descrizione</th> <th>Qtà</th> <th>UM</th> </tr> </thead> <tbody> <tr> <td>VE1170A0</td> <td>SUPPORTO D16 ELLITTICO NICHEL OPACO</td> <td>1</td> <td>PZ</td> </tr> <tr> <td>VE1530A0</td> <td>GEMMA ELLITTICA AZZURRA TERMOMETR O ORO</td> <td>1</td> <td>PZ</td> </tr> <tr> <td>VE1535A1</td> <td>LUCE SPIA LED BIANCO 230V</td> <td>1</td> <td>PZ</td> </tr> <tr> <td>VM1762A0</td> <td>SUPPORTO LAMPADA INTERNO</td> <td>1</td> <td>PZ</td> </tr> </tbody> </table>	Codice	Descrizione	Qtà	UM	VE1170A0	SUPPORTO D16 ELLITTICO NICHEL OPACO	1	PZ	VE1530A0	GEMMA ELLITTICA AZZURRA TERMOMETR O ORO	1	PZ	VE1535A1	LUCE SPIA LED BIANCO 230V	1	PZ	VM1762A0	SUPPORTO LAMPADA INTERNO	1	PZ
			Codice	Descrizione	Qtà	UM																			
VE1170A0	SUPPORTO D16 ELLITTICO NICHEL OPACO	1	PZ																						
VE1530A0	GEMMA ELLITTICA AZZURRA TERMOMETR O ORO	1	PZ																						
VE1535A1	LUCE SPIA LED BIANCO 230V	1	PZ																						
VM1762A0	SUPPORTO LAMPADA INTERNO	1	PZ																						
KLP1010A	KIT SPIA VERDE TERMOSTATO	<table border="1"> <thead> <tr> <th>Codice</th> <th>Descrizione</th> <th>Qtà</th> <th>UM</th> </tr> </thead> <tbody> <tr> <td>VE1170A0</td> <td>SUPPORTO D16 ELLITTICO NICHEL OPACO</td> <td>1</td> <td>PZ</td> </tr> <tr> <td>VE1535A1</td> <td>LUCE SPIA LED BIANCO 230V</td> <td>1</td> <td>PZ</td> </tr> <tr> <td>VM1762A0</td> <td>SUPPORTO LAMPADA INTERNO</td> <td>1</td> <td>PZ</td> </tr> <tr> <td>VM1764A0</td> <td>GEMMA VERDE TERMOMETR O ORO</td> <td>1</td> <td>PZ</td> </tr> </tbody> </table>	Codice	Descrizione	Qtà	UM	VE1170A0	SUPPORTO D16 ELLITTICO NICHEL OPACO	1	PZ	VE1535A1	LUCE SPIA LED BIANCO 230V	1	PZ	VM1762A0	SUPPORTO LAMPADA INTERNO	1	PZ	VM1764A0	GEMMA VERDE TERMOMETR O ORO	1	PZ			
Codice	Descrizione	Qtà	UM																						
VE1170A0	SUPPORTO D16 ELLITTICO NICHEL OPACO	1	PZ																						
VE1535A1	LUCE SPIA LED BIANCO 230V	1	PZ																						
VM1762A0	SUPPORTO LAMPADA INTERNO	1	PZ																						
VM1764A0	GEMMA VERDE TERMOMETR O ORO	1	PZ																						
VE1170A	SUPPORTO D16 ELLITTICO NICHEL OPACO		KVE0108A	KIT TASTO 0 - 1 ARGENTO OPACO	<table border="1"> <thead> <tr> <th>Codice</th> <th>Descrizione</th> <th>Qtà</th> <th>UM</th> </tr> </thead> <tbody> <tr> <td>VE1170A0</td> <td>SUPPORTO D16 ELLITTICO NICHEL OPACO</td> <td>1</td> <td>PZ</td> </tr> <tr> <td>VE1561A0</td> <td>INTERRUTTO RE BIPOLARE NA/NA</td> <td>1</td> <td>PZ</td> </tr> <tr> <td>VM1761A0</td> <td>SUPPORTO ELLITTICO NERO</td> <td>1</td> <td>PZ</td> </tr> <tr> <td>VM1776A0</td> <td>TASTO ARGENTO OPACO "0-1" ORO</td> <td>1</td> <td>PZ</td> </tr> </tbody> </table>	Codice	Descrizione	Qtà	UM	VE1170A0	SUPPORTO D16 ELLITTICO NICHEL OPACO	1	PZ	VE1561A0	INTERRUTTO RE BIPOLARE NA/NA	1	PZ	VM1761A0	SUPPORTO ELLITTICO NERO	1	PZ	VM1776A0	TASTO ARGENTO OPACO "0-1" ORO	1	PZ
			Codice	Descrizione	Qtà	UM																			
VE1170A0	SUPPORTO D16 ELLITTICO NICHEL OPACO	1	PZ																						
VE1561A0	INTERRUTTO RE BIPOLARE NA/NA	1	PZ																						
VM1761A0	SUPPORTO ELLITTICO NERO	1	PZ																						
VM1776A0	TASTO ARGENTO OPACO "0-1" ORO	1	PZ																						
KLP1014A	KIT RICAMBIO SPIA AZZURRA SINUSOID	<table border="1"> <thead> <tr> <th>Codice</th> <th>Descrizione</th> <th>Qtà</th> <th>UM</th> </tr> </thead> <tbody> <tr> <td>VE1170A0</td> <td>SUPPORTO D16 ELLITTICO NICHEL OPACO</td> <td>2</td> <td>PZ</td> </tr> <tr> <td>VE1535A1</td> <td>LUCE SPIA LED BIANCO 230V</td> <td>2</td> <td>PZ</td> </tr> </tbody> </table>	Codice	Descrizione	Qtà	UM	VE1170A0	SUPPORTO D16 ELLITTICO NICHEL OPACO	2	PZ	VE1535A1	LUCE SPIA LED BIANCO 230V	2	PZ											
Codice	Descrizione	Qtà	UM																						
VE1170A0	SUPPORTO D16 ELLITTICO NICHEL OPACO	2	PZ																						
VE1535A1	LUCE SPIA LED BIANCO 230V	2	PZ																						

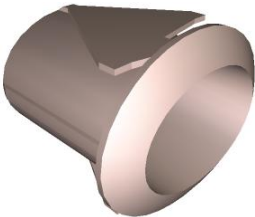
COMPONENTE			RICAMBIO																						
Codice	Descrizione	Immagine	Codice	Descrizione	Lista componenti																				
VE1170A	SUPPORTO D16 ELLITTICO NICHEL OPACO		KLP1014A	KIT RICAMBIO SPIA AZZURRA SINUSOID	<table border="1"> <thead> <tr> <th>Codice</th> <th>Descrizione</th> <th>Qtà</th> <th>UM</th> </tr> </thead> <tbody> <tr> <td>VE1585A0</td> <td>GEMMA ELLITTICA AZZURRA SINUSOIDE ORO</td> <td>2</td> <td>PZ</td> </tr> <tr> <td>VM1762A0</td> <td>SUPPORTO LAMPADA INTERNO</td> <td>2</td> <td>PZ</td> </tr> <tr> <td>VM2009A0</td> <td>SUPPORTO ELLITTICO D16 ARGENTO</td> <td>1</td> <td>PZ</td> </tr> </tbody> </table>	Codice	Descrizione	Qtà	UM	VE1585A0	GEMMA ELLITTICA AZZURRA SINUSOIDE ORO	2	PZ	VM1762A0	SUPPORTO LAMPADA INTERNO	2	PZ	VM2009A0	SUPPORTO ELLITTICO D16 ARGENTO	1	PZ				
			Codice	Descrizione	Qtà	UM																			
			VE1585A0	GEMMA ELLITTICA AZZURRA SINUSOIDE ORO	2	PZ																			
			VM1762A0	SUPPORTO LAMPADA INTERNO	2	PZ																			
			VM2009A0	SUPPORTO ELLITTICO D16 ARGENTO	1	PZ																			
			KLP1012A	KIT SPIA AZZURRA TERMOSTATO	<table border="1"> <thead> <tr> <th>Codice</th> <th>Descrizione</th> <th>Qtà</th> <th>UM</th> </tr> </thead> <tbody> <tr> <td>VE1170A0</td> <td>SUPPORTO D16 ELLITTICO NICHEL OPAC</td> <td>1</td> <td>PZ</td> </tr> <tr> <td>VE1530A0</td> <td>GEMMA ELLITTICA AZZURRA TERMOMETR O ORO</td> <td>1</td> <td>PZ</td> </tr> <tr> <td>VE1535A1</td> <td>LUCE SPIA LED BIANCO 230V</td> <td>1</td> <td>PZ</td> </tr> <tr> <td>VM1762A0</td> <td>SUPPORTO LAMPADA INTERNO</td> <td>1</td> <td>PZ</td> </tr> </tbody> </table>	Codice	Descrizione	Qtà	UM	VE1170A0	SUPPORTO D16 ELLITTICO NICHEL OPAC	1	PZ	VE1530A0	GEMMA ELLITTICA AZZURRA TERMOMETR O ORO	1	PZ	VE1535A1	LUCE SPIA LED BIANCO 230V	1	PZ	VM1762A0	SUPPORTO LAMPADA INTERNO	1	PZ
			Codice	Descrizione	Qtà	UM																			
			VE1170A0	SUPPORTO D16 ELLITTICO NICHEL OPAC	1	PZ																			
			VE1530A0	GEMMA ELLITTICA AZZURRA TERMOMETR O ORO	1	PZ																			
			VE1535A1	LUCE SPIA LED BIANCO 230V	1	PZ																			
			VM1762A0	SUPPORTO LAMPADA INTERNO	1	PZ																			
			KLP1011A	KIT SPIA TERMOSTATO SUPP.NICHELATO 110V	<table border="1"> <thead> <tr> <th>Codice</th> <th>Descrizione</th> <th>Qtà</th> <th>UM</th> </tr> </thead> <tbody> <tr> <td>VE1170A0</td> <td>SUPPORTO D16 ELLITTICO NICHEL OPAC</td> <td>1</td> <td>PZ</td> </tr> <tr> <td>VE1530A0</td> <td>GEMMA ELLITTICA AZZURRA TERMOMETR O ORO</td> <td>1</td> <td>PZ</td> </tr> <tr> <td>VE1535A1</td> <td>LUCE SPIA LED BIANCO 230V</td> <td>1</td> <td>PZ</td> </tr> <tr> <td>VM1762A0</td> <td>SUPPORTO LAMPADA INTERNO</td> <td>1</td> <td>PZ</td> </tr> </tbody> </table>	Codice	Descrizione	Qtà	UM	VE1170A0	SUPPORTO D16 ELLITTICO NICHEL OPAC	1	PZ	VE1530A0	GEMMA ELLITTICA AZZURRA TERMOMETR O ORO	1	PZ	VE1535A1	LUCE SPIA LED BIANCO 230V	1	PZ	VM1762A0	SUPPORTO LAMPADA INTERNO	1	PZ
Codice	Descrizione	Qtà	UM																						
VE1170A0	SUPPORTO D16 ELLITTICO NICHEL OPAC	1	PZ																						
VE1530A0	GEMMA ELLITTICA AZZURRA TERMOMETR O ORO	1	PZ																						
VE1535A1	LUCE SPIA LED BIANCO 230V	1	PZ																						
VM1762A0	SUPPORTO LAMPADA INTERNO	1	PZ																						
KLP1010A	KIT SPIA VERDE TERMOSTATO	<table border="1"> <thead> <tr> <th>Codice</th> <th>Descrizione</th> <th>Qtà</th> <th>UM</th> </tr> </thead> <tbody> <tr> <td>VE1170A0</td> <td>SUPPORTO D16 ELLITTICO NICHEL OPAC</td> <td>1</td> <td>PZ</td> </tr> <tr> <td>VE1535A1</td> <td>LUCE SPIA LED BIANCO 230V</td> <td>1</td> <td>PZ</td> </tr> <tr> <td>VM1762A0</td> <td>SUPPORTO LAMPADA INTERNO</td> <td>1</td> <td>PZ</td> </tr> <tr> <td>VM1764A0</td> <td>GEMMA VERDE TERMOMETR O ORO</td> <td>1</td> <td>PZ</td> </tr> </tbody> </table>	Codice	Descrizione	Qtà	UM	VE1170A0	SUPPORTO D16 ELLITTICO NICHEL OPAC	1	PZ	VE1535A1	LUCE SPIA LED BIANCO 230V	1	PZ	VM1762A0	SUPPORTO LAMPADA INTERNO	1	PZ	VM1764A0	GEMMA VERDE TERMOMETR O ORO	1	PZ			
Codice	Descrizione	Qtà	UM																						
VE1170A0	SUPPORTO D16 ELLITTICO NICHEL OPAC	1	PZ																						
VE1535A1	LUCE SPIA LED BIANCO 230V	1	PZ																						
VM1762A0	SUPPORTO LAMPADA INTERNO	1	PZ																						
VM1764A0	GEMMA VERDE TERMOMETR O ORO	1	PZ																						

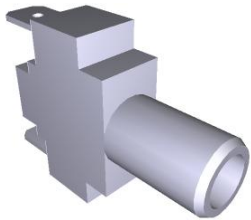
COMPONENTE			RICAMBIO																																			
Codice	Descrizione	Immagine	Codice	Descrizione	Lista componenti																																	
VE1562A	PULSANTE UNIPOLARE NA		KVE0107A	KIT GEMMA NUVOLETTA ARGENTO	<table border="1"> <thead> <tr> <th>Codice</th> <th>Descrizione</th> <th>Qtà</th> <th>UM</th> </tr> </thead> <tbody> <tr> <td>VE1170A0</td> <td>SUPPORTO D16 ELLITTICO NICHEL OPAC</td> <td>1</td> <td>PZ</td> </tr> <tr> <td>VE1562A0</td> <td>PULSANTE UNIPOLARE N</td> <td>1</td> <td>PZ</td> </tr> <tr> <td>VM1761A0</td> <td>SUPPORTO ELLITTICO NERO</td> <td>1</td> <td>PZ</td> </tr> <tr> <td>VM1775A0</td> <td>TASTO ARGENTO OPACO NUVOLETTA ORO</td> <td>1</td> <td>PZ</td> </tr> </tbody> </table>	Codice	Descrizione	Qtà	UM	VE1170A0	SUPPORTO D16 ELLITTICO NICHEL OPAC	1	PZ	VE1562A0	PULSANTE UNIPOLARE N	1	PZ	VM1761A0	SUPPORTO ELLITTICO NERO	1	PZ	VM1775A0	TASTO ARGENTO OPACO NUVOLETTA ORO	1	PZ													
			Codice	Descrizione	Qtà	UM																																
			VE1170A0	SUPPORTO D16 ELLITTICO NICHEL OPAC	1	PZ																																
VE1562A0	PULSANTE UNIPOLARE N	1	PZ																																			
VM1761A0	SUPPORTO ELLITTICO NERO	1	PZ																																			
VM1775A0	TASTO ARGENTO OPACO NUVOLETTA ORO	1	PZ																																			
KVE0106A	KIT GEMMA FIAMMA ARG.	<table border="1"> <thead> <tr> <th>Codice</th> <th>Descrizione</th> <th>Qtà</th> <th>UM</th> </tr> </thead> <tbody> <tr> <td>VE1562A0</td> <td>PULSANTE UNIPOLARE N</td> <td>1</td> <td>PZ</td> </tr> <tr> <td>VM1761A0</td> <td>SUPPORTO ELLITTICO NERO</td> <td>1</td> <td>PZ</td> </tr> <tr> <td>VM1774A0</td> <td>TASTO ARGENTO OPACO FIAMMA ORO</td> <td>1</td> <td>PZ</td> </tr> </tbody> </table>	Codice	Descrizione	Qtà	UM	VE1562A0	PULSANTE UNIPOLARE N	1	PZ	VM1761A0	SUPPORTO ELLITTICO NERO	1	PZ	VM1774A0	TASTO ARGENTO OPACO FIAMMA ORO	1	PZ																				
Codice	Descrizione	Qtà	UM																																			
VE1562A0	PULSANTE UNIPOLARE N	1	PZ																																			
VM1761A0	SUPPORTO ELLITTICO NERO	1	PZ																																			
VM1774A0	TASTO ARGENTO OPACO FIAMMA ORO	1	PZ																																			
KVE0008A	KIT GEMME AZZURRE XL	<table border="1"> <thead> <tr> <th>Codice</th> <th>Descrizione</th> <th>Qtà</th> <th>UM</th> </tr> </thead> <tbody> <tr> <td>VE1530A0</td> <td>GEMMA ELLITTICA AZZURRA TERMOMETR O ORO</td> <td>1</td> <td>PZ</td> </tr> <tr> <td>VE1535A1</td> <td>LUCE SPIA LED BIANCO 230V</td> <td>1</td> <td>PZ</td> </tr> <tr> <td>VE1561A0</td> <td>INTERRUTTO RE BIPOLARE NA/NA</td> <td>1</td> <td>PZ</td> </tr> <tr> <td>VE1562A0</td> <td>PULSANTE UNIPOLARE N</td> <td>1</td> <td>PZ</td> </tr> <tr> <td>VM1761A0</td> <td>SUPPORTO ELLITTICO NERO</td> <td>3</td> <td>PZ</td> </tr> <tr> <td>VM1762A0</td> <td>SUPPORTO LAMPADA INTERNO</td> <td>1</td> <td>PZ</td> </tr> <tr> <td>VM1775A0</td> <td>TASTO ARGENTO OPACO NUVOLETTA ORO</td> <td>1</td> <td>PZ</td> </tr> <tr> <td>VM1776A0</td> <td>TASTO ARGENTO OPACO "0-1" ORO</td> <td>1</td> <td>PZ</td> </tr> </tbody> </table>	Codice	Descrizione	Qtà	UM	VE1530A0	GEMMA ELLITTICA AZZURRA TERMOMETR O ORO	1	PZ	VE1535A1	LUCE SPIA LED BIANCO 230V	1	PZ	VE1561A0	INTERRUTTO RE BIPOLARE NA/NA	1	PZ	VE1562A0	PULSANTE UNIPOLARE N	1	PZ	VM1761A0	SUPPORTO ELLITTICO NERO	3	PZ	VM1762A0	SUPPORTO LAMPADA INTERNO	1	PZ	VM1775A0	TASTO ARGENTO OPACO NUVOLETTA ORO	1	PZ	VM1776A0	TASTO ARGENTO OPACO "0-1" ORO	1	PZ
Codice	Descrizione	Qtà	UM																																			
VE1530A0	GEMMA ELLITTICA AZZURRA TERMOMETR O ORO	1	PZ																																			
VE1535A1	LUCE SPIA LED BIANCO 230V	1	PZ																																			
VE1561A0	INTERRUTTO RE BIPOLARE NA/NA	1	PZ																																			
VE1562A0	PULSANTE UNIPOLARE N	1	PZ																																			
VM1761A0	SUPPORTO ELLITTICO NERO	3	PZ																																			
VM1762A0	SUPPORTO LAMPADA INTERNO	1	PZ																																			
VM1775A0	TASTO ARGENTO OPACO NUVOLETTA ORO	1	PZ																																			
VM1776A0	TASTO ARGENTO OPACO "0-1" ORO	1	PZ																																			

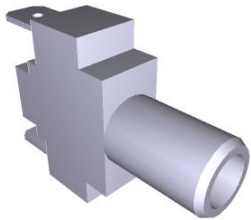
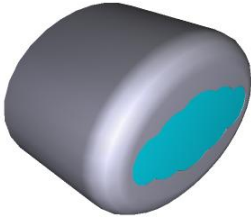
COMPONENTE			RICAMBIO																																																		
Codice	Descrizione	Immagine	Codice	Descrizione	Lista componenti																																																
VE1562A	PULSANTE UNIPOLARE NA		KVE0007A	KIT GEMME XF-XG	<table border="1"> <thead> <tr> <th>Codice</th> <th>Descrizione</th> <th>Qtà</th> <th>UM</th> </tr> </thead> <tbody> <tr> <td>VE1530A0</td> <td>GEMMA ELLITTICA AZZURRA TERMOMETR O ORO</td> <td>1</td> <td>PZ</td> </tr> <tr> <td>VE1535A1</td> <td>LUCE SPIA LED BIANCO 230V</td> <td>1</td> <td>PZ</td> </tr> <tr> <td>VE1562A0</td> <td>PULSANTE UNIPOLARE N</td> <td>1</td> <td>PZ</td> </tr> <tr> <td>VE1585A0</td> <td>GEMMA ELLITTICA AZZURRA SINUSOIDE ORO</td> <td>1</td> <td>PZ</td> </tr> <tr> <td>VM1761A0</td> <td>SUPPORTO ELLITTICO NERO</td> <td>5</td> <td>PZ</td> </tr> <tr> <td>VM1762A0</td> <td>SUPPORTO LAMPADA INTERNO</td> <td>4</td> <td>PZ</td> </tr> <tr> <td>VM1767A0</td> <td>GEMMA VERDE FIAMMA ORO</td> <td>1</td> <td>PZ</td> </tr> <tr> <td>VM1774A0</td> <td>TASTO ARGENTO OPACO FIAMMA ORO</td> <td>1</td> <td>PZ</td> </tr> <tr> <td>VM1775A0</td> <td>TASTO ARGENTO OPACO NUVOLETTA ORO</td> <td>1</td> <td>PZ</td> </tr> <tr> <td>VM1902A0</td> <td>GEMMA VERDE NEUTR</td> <td>1</td> <td>PZ</td> </tr> <tr> <td>VM1903A0</td> <td>GEMMA VERDE NUVOLETTA ORO</td> <td>1</td> <td>PZ</td> </tr> </tbody> </table>	Codice	Descrizione	Qtà	UM	VE1530A0	GEMMA ELLITTICA AZZURRA TERMOMETR O ORO	1	PZ	VE1535A1	LUCE SPIA LED BIANCO 230V	1	PZ	VE1562A0	PULSANTE UNIPOLARE N	1	PZ	VE1585A0	GEMMA ELLITTICA AZZURRA SINUSOIDE ORO	1	PZ	VM1761A0	SUPPORTO ELLITTICO NERO	5	PZ	VM1762A0	SUPPORTO LAMPADA INTERNO	4	PZ	VM1767A0	GEMMA VERDE FIAMMA ORO	1	PZ	VM1774A0	TASTO ARGENTO OPACO FIAMMA ORO	1	PZ	VM1775A0	TASTO ARGENTO OPACO NUVOLETTA ORO	1	PZ	VM1902A0	GEMMA VERDE NEUTR	1	PZ	VM1903A0	GEMMA VERDE NUVOLETTA ORO	1	PZ
Codice	Descrizione	Qtà	UM																																																		
VE1530A0	GEMMA ELLITTICA AZZURRA TERMOMETR O ORO	1	PZ																																																		
VE1535A1	LUCE SPIA LED BIANCO 230V	1	PZ																																																		
VE1562A0	PULSANTE UNIPOLARE N	1	PZ																																																		
VE1585A0	GEMMA ELLITTICA AZZURRA SINUSOIDE ORO	1	PZ																																																		
VM1761A0	SUPPORTO ELLITTICO NERO	5	PZ																																																		
VM1762A0	SUPPORTO LAMPADA INTERNO	4	PZ																																																		
VM1767A0	GEMMA VERDE FIAMMA ORO	1	PZ																																																		
VM1774A0	TASTO ARGENTO OPACO FIAMMA ORO	1	PZ																																																		
VM1775A0	TASTO ARGENTO OPACO NUVOLETTA ORO	1	PZ																																																		
VM1902A0	GEMMA VERDE NEUTR	1	PZ																																																		
VM1903A0	GEMMA VERDE NUVOLETTA ORO	1	PZ																																																		
VM1775A	TASTO ARGENTO OPACO NUVOLETTA ORO		KVE0107A	KIT GEMMA NUVOLETTA ARGENTO	<table border="1"> <thead> <tr> <th>Codice</th> <th>Descrizione</th> <th>Qtà</th> <th>UM</th> </tr> </thead> <tbody> <tr> <td>VE1170A0</td> <td>SUPPORTO D16 ELLITTICO NICHEL OPAC</td> <td>1</td> <td>PZ</td> </tr> <tr> <td>VE1562A0</td> <td>PULSANTE UNIPOLARE N</td> <td>1</td> <td>PZ</td> </tr> <tr> <td>VM1761A0</td> <td>SUPPORTO ELLITTICO NERO</td> <td>1</td> <td>PZ</td> </tr> <tr> <td>VM1775A0</td> <td>TASTO ARGENTO OPACO NUVOLETTA ORO</td> <td>1</td> <td>PZ</td> </tr> </tbody> </table>	Codice	Descrizione	Qtà	UM	VE1170A0	SUPPORTO D16 ELLITTICO NICHEL OPAC	1	PZ	VE1562A0	PULSANTE UNIPOLARE N	1	PZ	VM1761A0	SUPPORTO ELLITTICO NERO	1	PZ	VM1775A0	TASTO ARGENTO OPACO NUVOLETTA ORO	1	PZ																												
Codice	Descrizione	Qtà	UM																																																		
VE1170A0	SUPPORTO D16 ELLITTICO NICHEL OPAC	1	PZ																																																		
VE1562A0	PULSANTE UNIPOLARE N	1	PZ																																																		
VM1761A0	SUPPORTO ELLITTICO NERO	1	PZ																																																		
VM1775A0	TASTO ARGENTO OPACO NUVOLETTA ORO	1	PZ																																																		

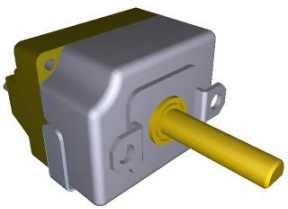
COMPONENTE			RICAMBIO																						
Codice	Descrizione	Immagine	Codice	Descrizione	Lista componenti																				
TM1005A	TIMER MI2 60 MIN 250V 16A		KTM1005A	KIT TIMER 60 MIN	<table border="1"> <thead> <tr> <th>Codice</th> <th>Descrizione</th> <th>Qtà</th> <th>UM</th> </tr> </thead> <tbody> <tr> <td>TM1005A0</td> <td>TIMER MI2 60 MIN 250V 16A</td> <td>1</td> <td>PZ</td> </tr> <tr> <td>VI1850A0</td> <td>VITE M4X6 TCB+ NICHELATA</td> <td>2</td> <td>PZ</td> </tr> </tbody> </table>	Codice	Descrizione	Qtà	UM	TM1005A0	TIMER MI2 60 MIN 250V 16A	1	PZ	VI1850A0	VITE M4X6 TCB+ NICHELATA	2	PZ								
Codice	Descrizione	Qtà	UM																						
TM1005A0	TIMER MI2 60 MIN 250V 16A	1	PZ																						
VI1850A0	VITE M4X6 TCB+ NICHELATA	2	PZ																						
MN1090B	MANOPOLA TIMER 0-60 MIN LM		KMN1090B	KIT MANOPOLA TIMER 0-60 MIN LINEMISS	<table border="1"> <thead> <tr> <th>Codice</th> <th>Descrizione</th> <th>Qtà</th> <th>UM</th> </tr> </thead> <tbody> <tr> <td>MN1090B1</td> <td>MANOPOLA TIMER 0-60 MIN LM</td> <td>1</td> <td>PZ</td> </tr> </tbody> </table>	Codice	Descrizione	Qtà	UM	MN1090B1	MANOPOLA TIMER 0-60 MIN LM	1	PZ												
Codice	Descrizione	Qtà	UM																						
MN1090B1	MANOPOLA TIMER 0-60 MIN LM	1	PZ																						
TR1100A	TERMOSTATO REG. 269°C 55.19052.80		KTR1100A	KIT TERMOSTATO REGOLAZIONE 269°	<table border="1"> <thead> <tr> <th>Codice</th> <th>Descrizione</th> <th>Qtà</th> <th>UM</th> </tr> </thead> <tbody> <tr> <td>TR1100A0</td> <td>TERMOSTATO REG. 269°C 55.19052.80</td> <td>1</td> <td>PZ</td> </tr> <tr> <td>VI1850A0</td> <td>VITE M4X6 TCB+ NICHELATA</td> <td>2</td> <td>PZ</td> </tr> </tbody> </table>	Codice	Descrizione	Qtà	UM	TR1100A0	TERMOSTATO REG. 269°C 55.19052.80	1	PZ	VI1850A0	VITE M4X6 TCB+ NICHELATA	2	PZ								
Codice	Descrizione	Qtà	UM																						
TR1100A0	TERMOSTATO REG. 269°C 55.19052.80	1	PZ																						
VI1850A0	VITE M4X6 TCB+ NICHELATA	2	PZ																						
MN1091B	MANOPOLA TERMOSTATO 80-260°C LM		KMN1091B	KIT MANOPOLA TERMOSTATO 80-260#C	<table border="1"> <thead> <tr> <th>Codice</th> <th>Descrizione</th> <th>Qtà</th> <th>UM</th> </tr> </thead> <tbody> <tr> <td>MN1091B1</td> <td>MANOPOLA TERMOSTATO 80-260°C LM</td> <td>1</td> <td>PZ</td> </tr> </tbody> </table>	Codice	Descrizione	Qtà	UM	MN1091B1	MANOPOLA TERMOSTATO 80-260°C LM	1	PZ												
Codice	Descrizione	Qtà	UM																						
MN1091B1	MANOPOLA TERMOSTATO 80-260°C LM	1	PZ																						
TM1001C	BUZZER ELETTRONICO 15S 120V		KTM1001C	KIT BUZZER 15 SEC	<table border="1"> <thead> <tr> <th>Codice</th> <th>Descrizione</th> <th>Qtà</th> <th>UM</th> </tr> </thead> <tbody> <tr> <td>TM1001C2</td> <td>BUZZER ELETTRONICO 15S 120V</td> <td>1</td> <td>PZ</td> </tr> <tr> <td>VI1220A1</td> <td>VITE AUTOFILETTA NTE 4.2X11 TCS+ MARUTE</td> <td>3</td> <td>PZ</td> </tr> <tr> <td>VI1850A0</td> <td>VITE M4X6 TCB+ NICHELATA</td> <td>3</td> <td>PZ</td> </tr> <tr> <td>VM1745A0</td> <td>SUPPORTO PER SCHEDA</td> <td>3</td> <td>PZ</td> </tr> </tbody> </table>	Codice	Descrizione	Qtà	UM	TM1001C2	BUZZER ELETTRONICO 15S 120V	1	PZ	VI1220A1	VITE AUTOFILETTA NTE 4.2X11 TCS+ MARUTE	3	PZ	VI1850A0	VITE M4X6 TCB+ NICHELATA	3	PZ	VM1745A0	SUPPORTO PER SCHEDA	3	PZ
Codice	Descrizione	Qtà	UM																						
TM1001C2	BUZZER ELETTRONICO 15S 120V	1	PZ																						
VI1220A1	VITE AUTOFILETTA NTE 4.2X11 TCS+ MARUTE	3	PZ																						
VI1850A0	VITE M4X6 TCB+ NICHELATA	3	PZ																						
VM1745A0	SUPPORTO PER SCHEDA	3	PZ																						

COMPONENTE			RICAMBIO														
<i>Codice</i>	<i>Descrizione</i>	<i>Immagine</i>	<i>Codice</i>	<i>Descrizione</i>	<i>Lista componenti</i>												
VM1225A	PIASTRINA PASSACAPO CONTROLLO CT BT		VM1225A1	PIASTRINA PASSACAPO CONTROLLO CT BT													
OD1300C	PROFILO INFERIORE FACCIATA LM 800		OD1300C0	PROFILO INFERIORE FACCIATA LM 800													
VM1556A	PROTEZIONE VENTOLA RAFFREDDAMENTO CT BT		KVM1556A	KIT PROTEZIONE VENTOLA RAFFREDDAMENTO	<table border="1"> <thead> <tr> <th>Codice</th> <th>Descrizione</th> <th>Qtà</th> <th>UM</th> </tr> </thead> <tbody> <tr> <td>VM1556A0</td> <td>PROTEZIONE VENTOLA RAFFREDAME NTO CT BT</td> <td>1</td> <td>PZ</td> </tr> </tbody> </table>	Codice	Descrizione	Qtà	UM	VM1556A0	PROTEZIONE VENTOLA RAFFREDAME NTO CT BT	1	PZ				
Codice	Descrizione	Qtà	UM														
VM1556A0	PROTEZIONE VENTOLA RAFFREDAME NTO CT BT	1	PZ														
VN1178A	VENTIL ASSIALE 120X120 115V 60HZ		KVN1178A	KIT VENTIL ASSIALE 120X120 115V 60HZ	<table border="1"> <thead> <tr> <th>Codice</th> <th>Descrizione</th> <th>Qtà</th> <th>UM</th> </tr> </thead> <tbody> <tr> <td>VN1178A0</td> <td>VENTIL ASSIALE 120X120 115V 60HZ</td> <td>1</td> <td>PZ</td> </tr> <tr> <td>VN1178A0</td> <td>VENTIL ASSIALE 120X120 115V 60HZ</td> <td>1</td> <td>PZ</td> </tr> </tbody> </table>	Codice	Descrizione	Qtà	UM	VN1178A0	VENTIL ASSIALE 120X120 115V 60HZ	1	PZ	VN1178A0	VENTIL ASSIALE 120X120 115V 60HZ	1	PZ
Codice	Descrizione	Qtà	UM														
VN1178A0	VENTIL ASSIALE 120X120 115V 60HZ	1	PZ														
VN1178A0	VENTIL ASSIALE 120X120 115V 60HZ	1	PZ														
VN1175A	VENTOLA RAFFR. 120X120 230V 50/60HZ 80°C		KVN1175A	KIT VENTOLA RAFFREDDAMENTO 120X120 230V	<table border="1"> <thead> <tr> <th>Codice</th> <th>Descrizione</th> <th>Qtà</th> <th>UM</th> </tr> </thead> <tbody> <tr> <td>VN1175A0</td> <td>VENTOLA RAFFR. 120X120 230V 50/60HZ 80°C</td> <td>1</td> <td>PZ</td> </tr> <tr> <td>VN1175A0</td> <td>VENTOLA RAFFR. 120X120 230V 50/60HZ 80°C</td> <td>1</td> <td>PZ</td> </tr> </tbody> </table>	Codice	Descrizione	Qtà	UM	VN1175A0	VENTOLA RAFFR. 120X120 230V 50/60HZ 80°C	1	PZ	VN1175A0	VENTOLA RAFFR. 120X120 230V 50/60HZ 80°C	1	PZ
Codice	Descrizione	Qtà	UM														
VN1175A0	VENTOLA RAFFR. 120X120 230V 50/60HZ 80°C	1	PZ														
VN1175A0	VENTOLA RAFFR. 120X120 230V 50/60HZ 80°C	1	PZ														

ASM2014F/0.D00 - Impianto elettrico

FRONTE

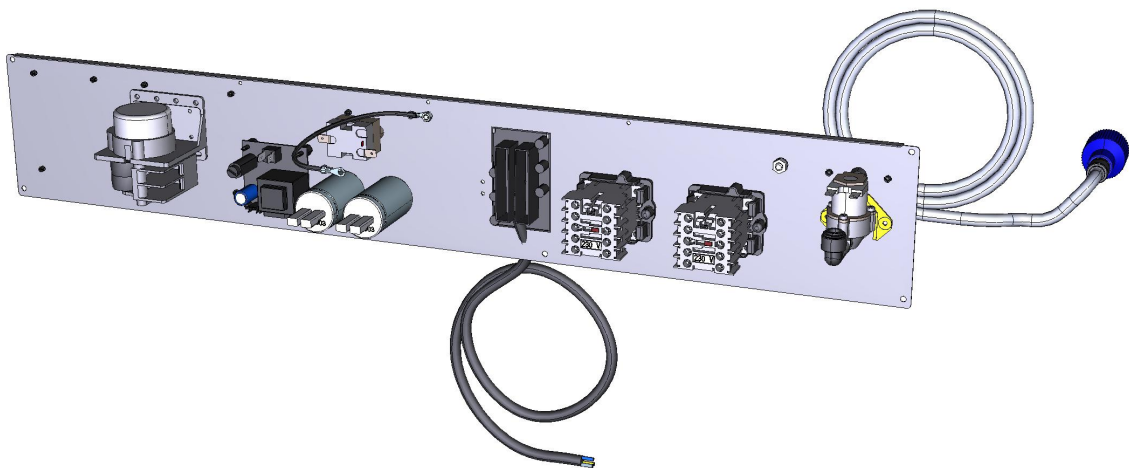

ASM2014F/0.D00 - Impianto elettrico

RETRO

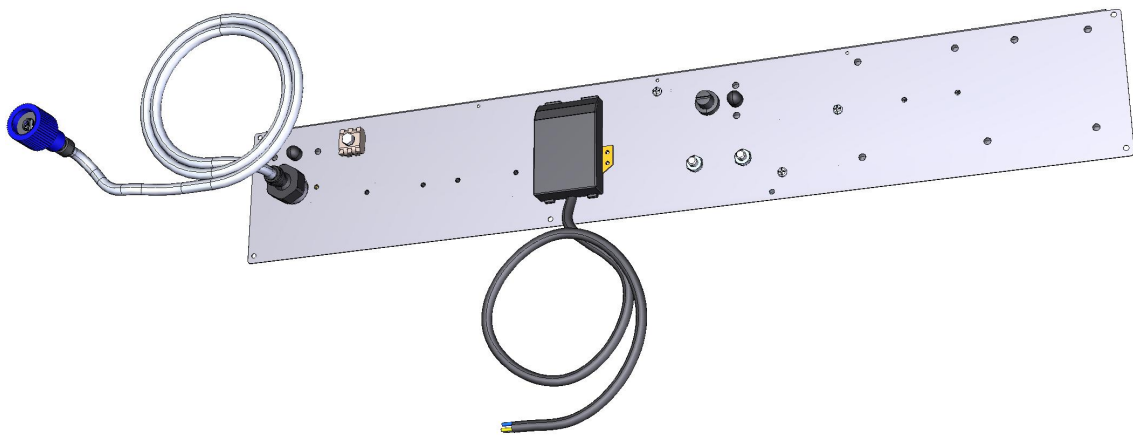

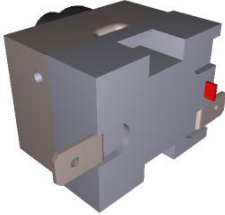
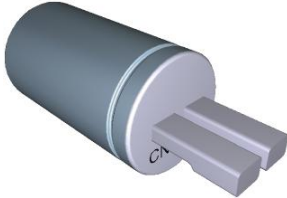
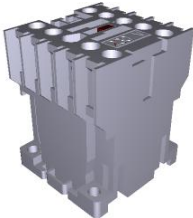
COMPONENTE			RICAMBIO																										
Codice	Descrizione	Immagine	Codice	Descrizione	Lista componenti																								
CE1130A	CAVO 5X1,5MMQ H07RN-F L=1,5M + MORS.K1/6		KCE1130A	KIT CAVO 5X1,5MMQ H07RN-F L=1,5M + MORS.	<table border="1"> <thead> <tr> <th>Codice</th> <th>Descrizione</th> <th>Qtà</th> <th>UM</th> </tr> </thead> <tbody> <tr> <td>CE1130A1</td> <td>CAVO 5X1,5MMQ H07RN-F L=1,5M + MORS.K1/6</td> <td>1</td> <td>PZ</td> </tr> </tbody> </table>	Codice	Descrizione	Qtà	UM	CE1130A1	CAVO 5X1,5MMQ H07RN-F L=1,5M + MORS.K1/6	1	PZ																
Codice	Descrizione	Qtà	UM																										
CE1130A1	CAVO 5X1,5MMQ H07RN-F L=1,5M + MORS.K1/6	1	PZ																										
TR1136A	TERMOSTATO SIC. UNIP. 330°C		KTR1136A	KIT TERMOSTATO SICUREZZA 330°C	<table border="1"> <thead> <tr> <th>Codice</th> <th>Descrizione</th> <th>Qtà</th> <th>UM</th> </tr> </thead> <tbody> <tr> <td>0H7030A0</td> <td>COPERCHIO INGRESSO BULBO</td> <td>1</td> <td>PZ</td> </tr> <tr> <td>GN1531A0</td> <td>GUARNIZIONE TENUTA INGRESSO BULBO</td> <td>1</td> <td>PZ</td> </tr> <tr> <td>SL1045A0</td> <td>SILICONE ANTRACITE S53 80 ML</td> <td>1</td> <td>PZ</td> </tr> <tr> <td>TR1136A0</td> <td>TERMOSTATO SIC. UNIP. 330°C</td> <td>1</td> <td>PZ</td> </tr> <tr> <td>VI1220A1</td> <td>VITE AUTOFILETTA NTE 4.2X11 TCS+ MARUTE</td> <td>3</td> <td>PZ</td> </tr> </tbody> </table>	Codice	Descrizione	Qtà	UM	0H7030A0	COPERCHIO INGRESSO BULBO	1	PZ	GN1531A0	GUARNIZIONE TENUTA INGRESSO BULBO	1	PZ	SL1045A0	SILICONE ANTRACITE S53 80 ML	1	PZ	TR1136A0	TERMOSTATO SIC. UNIP. 330°C	1	PZ	VI1220A1	VITE AUTOFILETTA NTE 4.2X11 TCS+ MARUTE	3	PZ
Codice	Descrizione	Qtà	UM																										
0H7030A0	COPERCHIO INGRESSO BULBO	1	PZ																										
GN1531A0	GUARNIZIONE TENUTA INGRESSO BULBO	1	PZ																										
SL1045A0	SILICONE ANTRACITE S53 80 ML	1	PZ																										
TR1136A0	TERMOSTATO SIC. UNIP. 330°C	1	PZ																										
VI1220A1	VITE AUTOFILETTA NTE 4.2X11 TCS+ MARUTE	3	PZ																										
CN1003A	CONDENSATORE CORAZZATO 6,3 UF		KCN1003A	KIT CONDENSATORE MOTORE 6,3 UF	<table border="1"> <thead> <tr> <th>Codice</th> <th>Descrizione</th> <th>Qtà</th> <th>UM</th> </tr> </thead> <tbody> <tr> <td>CN1003A0</td> <td>CONDENSATO RE CORAZZATO 6,3 UF</td> <td>1</td> <td>PZ</td> </tr> <tr> <td>VI1931A0</td> <td>DADO M8X1.65 H4 CH13 ZINCATO</td> <td>1</td> <td>PZ</td> </tr> <tr> <td>VI1932A0</td> <td>RONDELLA DENTELLATA D8 ZINCATA</td> <td>1</td> <td>PZ</td> </tr> </tbody> </table>	Codice	Descrizione	Qtà	UM	CN1003A0	CONDENSATO RE CORAZZATO 6,3 UF	1	PZ	VI1931A0	DADO M8X1.65 H4 CH13 ZINCATO	1	PZ	VI1932A0	RONDELLA DENTELLATA D8 ZINCATA	1	PZ								
Codice	Descrizione	Qtà	UM																										
CN1003A0	CONDENSATO RE CORAZZATO 6,3 UF	1	PZ																										
VI1931A0	DADO M8X1.65 H4 CH13 ZINCATO	1	PZ																										
VI1932A0	RONDELLA DENTELLATA D8 ZINCATA	1	PZ																										
VE1115A	MINICONTATTORE QUADRIPOLORE 20 A 230V		KVE1115A	KIT MINICONTATTORE QUADRIPOLORE 20A 230V	<table border="1"> <thead> <tr> <th>Codice</th> <th>Descrizione</th> <th>Qtà</th> <th>UM</th> </tr> </thead> <tbody> <tr> <td>VE1115A0</td> <td>MINICONTATT ORE QUADRIPOLO RE 20 A 230V</td> <td>1</td> <td>PZ</td> </tr> <tr> <td>VM1075A1</td> <td>CLIP DI FISSAGGIO PER TELERUTTORI</td> <td>4</td> <td>PZ</td> </tr> </tbody> </table>	Codice	Descrizione	Qtà	UM	VE1115A0	MINICONTATT ORE QUADRIPOLO RE 20 A 230V	1	PZ	VM1075A1	CLIP DI FISSAGGIO PER TELERUTTORI	4	PZ												
Codice	Descrizione	Qtà	UM																										
VE1115A0	MINICONTATT ORE QUADRIPOLO RE 20 A 230V	1	PZ																										
VM1075A1	CLIP DI FISSAGGIO PER TELERUTTORI	4	PZ																										

COMPONENTE			RICAMBIO																										
Codice	Descrizione	Immagine	Codice	Descrizione	Lista componenti																								
VM1056A	STAFFA TELERUTTORE PICCOLO VE1115A		VM1056A0	STAFFA TELERUTTORE PICCOLO VE1115A																									
VM1750A	MORSETTO A PETTINE		KVM1750A	KIT MORSETTIERA A PETTINE	<table border="1"> <thead> <tr> <th>Codice</th> <th>Descrizione</th> <th>Qtà</th> <th>UM</th> </tr> </thead> <tbody> <tr> <td>VM1750A0</td> <td>MORSETTO A PETTINE</td> <td>1</td> <td>PZ</td> </tr> </tbody> </table>	Codice	Descrizione	Qtà	UM	VM1750A0	MORSETTO A PETTINE	1	PZ																
Codice	Descrizione	Qtà	UM																										
VM1750A0	MORSETTO A PETTINE	1	PZ																										
EL1085A	ELETR.SING. ATT. J.GUEST INCORPORATO		KEL1085A	KIT ELETTROVALVOLA 1 VIA	<table border="1"> <thead> <tr> <th>Codice</th> <th>Descrizione</th> <th>Qtà</th> <th>UM</th> </tr> </thead> <tbody> <tr> <td>EL1085A0</td> <td>ELETR.SING. ATT. J.GUEST INCORPORAT</td> <td>1</td> <td>PZ</td> </tr> </tbody> </table>	Codice	Descrizione	Qtà	UM	EL1085A0	ELETR.SING. ATT. J.GUEST INCORPORAT	1	PZ																
Codice	Descrizione	Qtà	UM																										
EL1085A0	ELETR.SING. ATT. J.GUEST INCORPORAT	1	PZ																										
TB1079A	TB1815A0 - D8 ALLACCIAMENTO RETE 1,5M		KTB1079A	KIT TUBO ALLACCIAMENTO IDRICO LMISS	<table border="1"> <thead> <tr> <th>Codice</th> <th>Descrizione</th> <th>Qtà</th> <th>UM</th> </tr> </thead> <tbody> <tr> <td>GN1200A1</td> <td>GUARNIZIONE D24 RACCORDO 3/4 SILICONE</td> <td>1</td> <td>PZ</td> </tr> <tr> <td>RC1002A0</td> <td>RACCORDO RIDUZIONE CODOLO 10M-8F</td> <td>1</td> <td>PZ</td> </tr> <tr> <td>RC1030A2</td> <td>RACCORDO DIRITTO Ø8 - 3/4 FEMMINA J</td> <td>1</td> <td>PZ</td> </tr> <tr> <td>RC1365A0</td> <td>RACCORDO JG FEMMINA 3/4"-10</td> <td>1</td> <td>PZ</td> </tr> <tr> <td>TB1815A0</td> <td>TUBO PE 7,93X4,75 TRASPARENT</td> <td>1.500</td> <td>M</td> </tr> </tbody> </table>	Codice	Descrizione	Qtà	UM	GN1200A1	GUARNIZIONE D24 RACCORDO 3/4 SILICONE	1	PZ	RC1002A0	RACCORDO RIDUZIONE CODOLO 10M-8F	1	PZ	RC1030A2	RACCORDO DIRITTO Ø8 - 3/4 FEMMINA J	1	PZ	RC1365A0	RACCORDO JG FEMMINA 3/4"-10	1	PZ	TB1815A0	TUBO PE 7,93X4,75 TRASPARENT	1.500	M
Codice	Descrizione	Qtà	UM																										
GN1200A1	GUARNIZIONE D24 RACCORDO 3/4 SILICONE	1	PZ																										
RC1002A0	RACCORDO RIDUZIONE CODOLO 10M-8F	1	PZ																										
RC1030A2	RACCORDO DIRITTO Ø8 - 3/4 FEMMINA J	1	PZ																										
RC1365A0	RACCORDO JG FEMMINA 3/4"-10	1	PZ																										
TB1815A0	TUBO PE 7,93X4,75 TRASPARENT	1.500	M																										

COMPONENTE			RICAMBIO																		
Codice	Descrizione	Immagine	Codice	Descrizione	Lista componenti																
RC1030A	RACCORDO DIRITTO Ø8 - 3/4 FEMMINA JG		KRC1030A	KIT 5 PZ RACCORDO DIRITTO Ø8-3/4 LMISS	<table border="1"> <thead> <tr> <th>Codice</th> <th>Descrizione</th> <th>Qtà</th> <th>UM</th> </tr> </thead> <tbody> <tr> <td>RC1030A2</td> <td>RACCORDO DIRITTO Ø8 - 3/4 FEMMINA J</td> <td>5</td> <td>PZ</td> </tr> </tbody> </table>	Codice	Descrizione	Qtà	UM	RC1030A2	RACCORDO DIRITTO Ø8 - 3/4 FEMMINA J	5	PZ								
Codice	Descrizione	Qtà	UM																		
RC1030A2	RACCORDO DIRITTO Ø8 - 3/4 FEMMINA J	5	PZ																		
RC1002A	RACCORDO RIDUZIONE CODOLO 10M-8F		KRC1002A	KIT 10 PZ RIDUZIONE CODOLO JG Ø10M-Ø8F	<table border="1"> <thead> <tr> <th>Codice</th> <th>Descrizione</th> <th>Qtà</th> <th>UM</th> </tr> </thead> <tbody> <tr> <td>RC1002A0</td> <td>RACCORDO RIDUZIONE CODOLO 10M-8F</td> <td>10</td> <td>PZ</td> </tr> </tbody> </table>	Codice	Descrizione	Qtà	UM	RC1002A0	RACCORDO RIDUZIONE CODOLO 10M-8F	10	PZ								
Codice	Descrizione	Qtà	UM																		
RC1002A0	RACCORDO RIDUZIONE CODOLO 10M-8F	10	PZ																		
RC1365A	RACCORDO JG FEMMINA 3/4"-10		KRC1365A	KIT ATTACCO ACQUA DI RETE 3/4"-10 O 8 JG	<table border="1"> <thead> <tr> <th>Codice</th> <th>Descrizione</th> <th>Qtà</th> <th>UM</th> </tr> </thead> <tbody> <tr> <td>GN1200A1</td> <td>GUARNIZIONE D24 RACCORDO 3/4 SILICONE</td> <td>1</td> <td>PZ</td> </tr> <tr> <td>RC1002A0</td> <td>RACCORDO RIDUZIONE CODOLO 10M-8F</td> <td>1</td> <td>PZ</td> </tr> <tr> <td>RC1365A0</td> <td>RACCORDO JG FEMMINA 3/4"-10</td> <td>1</td> <td>PZ</td> </tr> </tbody> </table>	Codice	Descrizione	Qtà	UM	GN1200A1	GUARNIZIONE D24 RACCORDO 3/4 SILICONE	1	PZ	RC1002A0	RACCORDO RIDUZIONE CODOLO 10M-8F	1	PZ	RC1365A0	RACCORDO JG FEMMINA 3/4"-10	1	PZ
Codice	Descrizione	Qtà	UM																		
GN1200A1	GUARNIZIONE D24 RACCORDO 3/4 SILICONE	1	PZ																		
RC1002A0	RACCORDO RIDUZIONE CODOLO 10M-8F	1	PZ																		
RC1365A0	RACCORDO JG FEMMINA 3/4"-10	1	PZ																		
0H6221F	PORTACOMPONEN TI LMISS800 DYNAMIC-MANUAL		0H6221F0	PORTACOMPONEN TI LMISS800 DYNAMIC-MANUAL																	
PE1781A	ALIMENTATORE 200-240VAC 12VCC 1,5VA		KPE1781A	KIT ALIMENTATORE 200-240VAC 12VCC 1.5VA	<table border="1"> <thead> <tr> <th>Codice</th> <th>Descrizione</th> <th>Qtà</th> <th>UM</th> </tr> </thead> <tbody> <tr> <td>PE1781A0</td> <td>ALIMENTATO RE 200-240VAC 12VCC 1,5VA</td> <td>1</td> <td>PZ</td> </tr> <tr> <td>VM1745A0</td> <td>SUPPORTO PER SCHEDA</td> <td>4</td> <td>PZ</td> </tr> <tr> <td>VM2147A0</td> <td>SPUGNA ESD ROSA LISCIA 410X343X15 M</td> <td>1</td> <td>PZ</td> </tr> </tbody> </table>	Codice	Descrizione	Qtà	UM	PE1781A0	ALIMENTATO RE 200-240VAC 12VCC 1,5VA	1	PZ	VM1745A0	SUPPORTO PER SCHEDA	4	PZ	VM2147A0	SPUGNA ESD ROSA LISCIA 410X343X15 M	1	PZ
Codice	Descrizione	Qtà	UM																		
PE1781A0	ALIMENTATO RE 200-240VAC 12VCC 1,5VA	1	PZ																		
VM1745A0	SUPPORTO PER SCHEDA	4	PZ																		
VM2147A0	SPUGNA ESD ROSA LISCIA 410X343X15 M	1	PZ																		

COMPONENTE			RICAMBIO																		
Codice	Descrizione	Immagine	Codice	Descrizione	Lista componenti																
VE1615A	INVERTITORE DI MARCIA		KVE1615A	KIT INVERTITORE MARCIA VE1615A	<table border="1"> <thead> <tr> <th>Codice</th> <th>Descrizione</th> <th>Qtà</th> <th>UM</th> </tr> </thead> <tbody> <tr> <td>0H1429A0</td> <td>LAMIERINO FISSAGGIO INVERTITORE VE1615A</td> <td>1</td> <td>PZ</td> </tr> <tr> <td>VE1615A0</td> <td>INVERTITORE DI MARCIA</td> <td>1</td> <td>PZ</td> </tr> <tr> <td>VI1960A0</td> <td>VITE AUTOFIL. 4.2X11 TCBS+ AISI410</td> <td>3</td> <td>PZ</td> </tr> </tbody> </table>	Codice	Descrizione	Qtà	UM	0H1429A0	LAMIERINO FISSAGGIO INVERTITORE VE1615A	1	PZ	VE1615A0	INVERTITORE DI MARCIA	1	PZ	VI1960A0	VITE AUTOFIL. 4.2X11 TCBS+ AISI410	3	PZ
Codice	Descrizione	Qtà	UM																		
0H1429A0	LAMIERINO FISSAGGIO INVERTITORE VE1615A	1	PZ																		
VE1615A0	INVERTITORE DI MARCIA	1	PZ																		
VI1960A0	VITE AUTOFIL. 4.2X11 TCBS+ AISI410	3	PZ																		